

MODEL: SP secure

(Combustible Gas Leak Detector)

Operating Manual



Version 2.2

SENKO
SenKo Co., Ltd

Guarantee and Repair

Senko Co., Ltd. guarantees the products of SP series for 12 months from the shipping date and repairs or replaces the defected product during warranty period. Nevertheless, Senko is not responsible for the following cases and would not repair or replace the product at no cost, such cases as the product has been purchased through the route that Senko does not approve, or as the product has been damaged or deformed mechanically by misuse of the user, or as the product has not been calibrated or replaced the parts according to processes in the operating manual.

In the event that any defect or issue of the product occurred during warranty period, Senko will cover all the expenses except transportation fee. After the period of warranty, the expenses of repair or replacement of the product and transportation will be in principle borne by the user. Senko will not be responsible for any indirect occurrence or accident and/or damage during the use of the product, and the guarantee shall be limited to the replacement of parts and product. The guarantee is applied only to the users who purchased the product at Senko's authorized dealers or agents, and the guaranteed repair is to be performed by the expert engineers of Senko's authorized aftercare center.

Product Introduction

SP secure is a portable gas leak detector necessary to secure user's safety and protect industrial facilities by detecting leakage of gas in earlier stage at the dangerous work environment where risk of explosion always exists. As it is configured with two buttons only, the method of operation and sensor calibration is easy and convenient. Also the %LEL and concentration value of inflammable gas (LPG/LNG, hydrogen, etc) can be displayed on a digital LCD monitor.

For the safety of users, workers and operators are to be fully alerted about the alarm circumstances by the loud alarm sound and warning icon displayed on LCD monitor when gas concentration is detected in excess of regulatory standard. In addition, a suction pump is built-in it and also featured with the function of On/Off for the pump and alarm sound so that the user can set up alarm values to properly meet with the circumstances involved and the alarm value such set up can be adjusted to best fit to the type of gas and circumstances of leakage. SP secure provides quick response to inflammable gas and also prevents in advance workers from the explosion by the leakage of gas and high risk of asphyxiation that may be resulted by the exposure to toxic gas for a certain period of time.

Contents of Operating Manual

Product Specification -----	03
Names of Exterior and Display -----	04
Start and End of Operation -----	05
Operation Method -----	06
Backlight, ON/OFF of Sound and Pump -----	07
Calibration -----	07
Method of Alarm Set and Display -----	09
Recharging -----	11
Battery & Sensor replacement-----	11
Applicable Battery -----	13
Notice for User -----	14

1. Product Specification

Model	SP secure		
Detecting Gas	LNG, LPG	H ₂ (KGS701/SS1178)	Xylene
Sampling Method	Auto sampling type		
Sensor Type	Catalytic	Electrochemical	IR
Detecting Range	0~100%LEL	0~1000ppm	0~100%LEL
Response Time(T ₉₀)	Within 10 sec.	Within 10 sec. Within 75 sec.	Within 90 sec.
Resolution	1 %LEL	1 ppm	1 %LEL
Display	Digital LCD(Alarm, Buzzer, Pump On-off, Battery, Backlight)		
Alarm	Buzzer alarm & LCD Display		
Gas Concentration Display	0~1% LEL – Digital bar 1~100% LEL – Numerical display	0~20 ppm – Digital bar 0~1,000 ppm – Numerical display	0~1% LEL – Digital bar 1~100% LEL – Numerical display
Explosion Proof	Ex d ia IIB T3		
Operating Temperature	- 20°C ~ 50°C		
Power	Recharger or AA Alkaline battery 3ea		
Continuous Operation	More than 12 hours		
Dimensions / Weight	55m(W) x 241mm(H) x33 mm(D) / 260g		
Standard Accessories	Protect Cover, Adapter for charge		
Options	Extension Probe(5M/10M)		







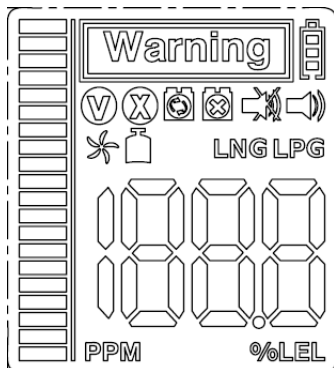

2. Names and Functions of Exterior



1. Gas inlet probe
2. Gas inlet filter
3. Gas outlet
4. Gas sensor
5. Buzzer
6. LCD display
7. Gas type
8. On/Off key & Pump On/Off key
9. Buzzer On/Off key & Back light On key
10. Battery cover
11. Protection Rubber Case

LCD display symbols



- | | | | |
|---|--------------------|---|------------------------|
|  | test pass |  | Sampling pump on |
|  | Test Failure |  | Sampling pump off |
| LNG | Detecting gas mode |  | Battery |
| LPG | Detecting gas mode |  | Fresh air calibration |
|  | Buzzer off |  | Single gas calibration |
|  | Buzzer on | | |

3. Start and End of Operation

Instrument Power-On



Press Power Key and power is turned on displaying 3,2 and 1 in order and all icons on LCD shall be blinking three times. Afterwards during the device is being stabilized, countdown is displayed on the screen. When stabilization of the device is completed, **V** mark appears with alarm sound and then converted to Gas Detection Mode.

Under normal status, **V** mark disappears in about 30 seconds and concentration of the gas detected of the moment is indicated. In the events that stabilization of the device fails, it would not convert to Gas Detection Mode, blinking the mark **X** with alarm sound. In this case, calibration of sensor or A/S of the device is required.

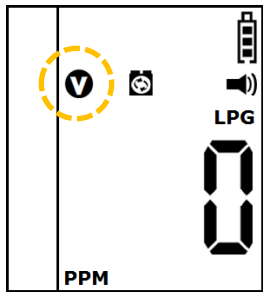

Test Success

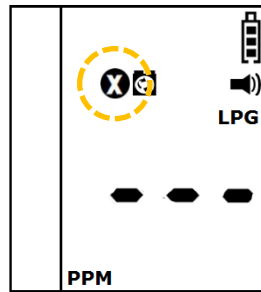

Test Fail

Instrument Power-Off



Press Power Key for 3 seconds and the digit 3,2 and 1 shall appear on the monitor in turn. After then power is turned off.

<Caution> Appropriate calibration of the device is always required prior to operation at the work site. Make sure if the device shows proper response to the pertinent gas and if the part sucking gas is not blocked with foreign materials that interfere the gas detection.

4. Operation Method

Detection Mode

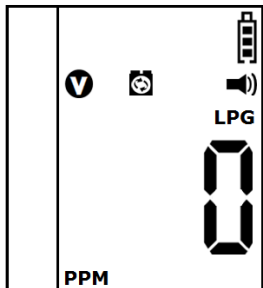

In case of LPG/LNG Detector, the device is converted to Gas Measure Mode as shown below when power button is turned on. Gas Measure Mode indicates the concentration of gas, operating status of suction pump, alarm sound On/Off status, battery level on LCD and it displays the concentration of flammable gas by %LEL and by PPM unit for Hydrogen. In the event that gases are detected, it indicates the value of concentration in real time and, if it exceeds the 1st and 2nd

alarm standard, the measured value shall be displayed blinking repeatedly along with **Warning!** mark and LO or HI indication.

The gas leakage detector raises an alarm along with digital bar when gas leakage is detected even in small amount, and the concentration value shall be reduced and alarm also shall be ceased when moved out to safe region where normal concentration value is measured. The alarm sound raised by the detection in the beginning stage can be stopped (OFF) with the Alarm Sound Off Button but the 1st and 2nd alarm sound can not be stopped. (Once alarm sound is raised, the mark shall not be disappeared even though the device is moved out to safe region (Can delete it by the OFF of Power Key). When the concentration value of the gas measured exceeds the maximum measuring range, it is indicated as the max value and it will be kept blink with one second interval. Also alarm sound relevant to the standard of 2nd alarm shall be raised along with indication.

Set Up of LPG/LNG gas

When buzzer key is pressed under the state of power Off, type of gas presently set shall be indicated. While buzzer key is pressed for 5 seconds, the set up for the type of gas shall be changed to LNG from LPG. Set up for LPG can be made in same manner as that done for LNG.

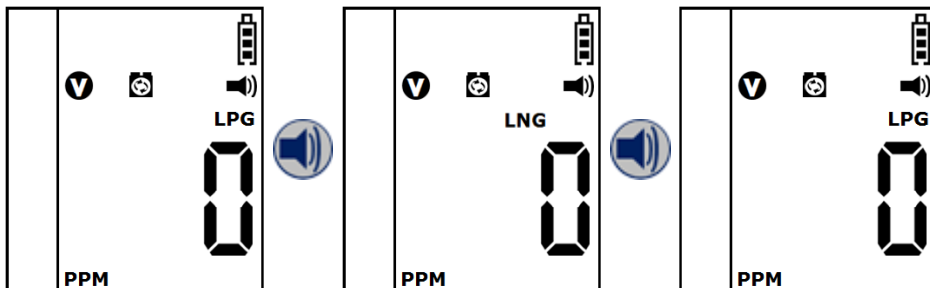

5. Backlight, ON/OFF of Sound and Pump

On/Off of Backlight and Sound

Alarm sound is also set to turn ON state when power key is pressed. All the following operations for ON/OFF of the Alarm Sound can be performed in the same way as that for suction pump above by using Alarm Sound key.

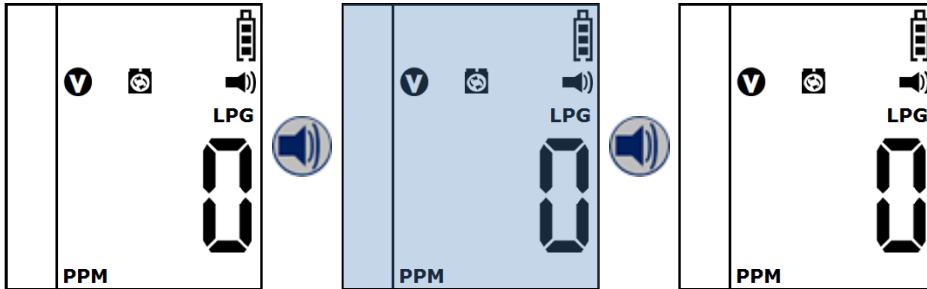

On/Off of Pump

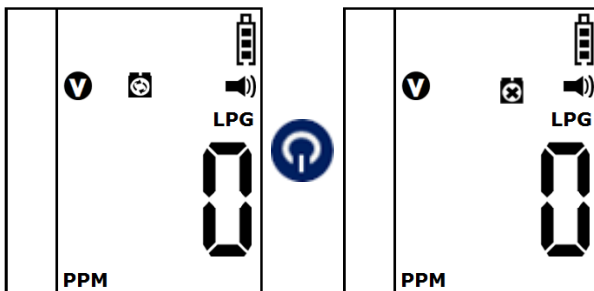

Suction pump is set to turn ON when power key is pressed. Press power key one more time to OFF suction pump. When power key is input once again, the function of suction pump returns to ON state as initially set.

6. Calibration



<Caution> Gas leakage detection can not be properly performed if the Suction Pump key is laid in OFF state. As the setting of OFF mode is to save battery while the device is not in service, Suction Pump has to be set ON all the time during the measure of gas leakage.

Fresh air Calibration

✧ icons shall blink if buzzer key is pressed for 3 seconds under the state power key is pressed simultaneously. Press power key at this state to enter into standby calibration mode. Calibration shall be completed in 10 second while processing countdown from 10,9,8...down to 3,2,1. When calibration is successfully completed, it returns to Gas Measure Mode with alarm sound after the **V** icons being blinked for 3 seconds.

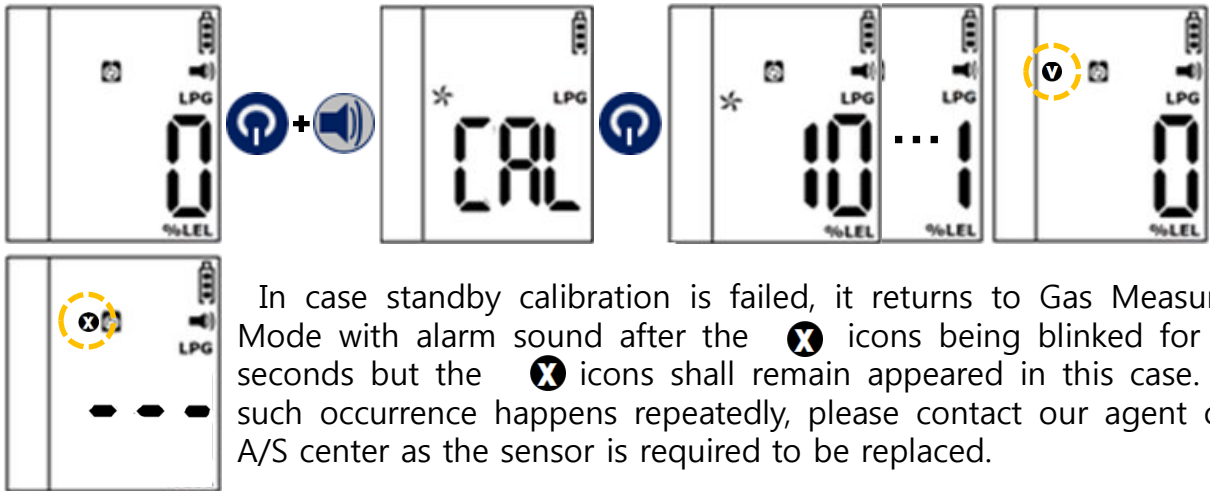

Standard Gas Calibration

Press buzzer key for three seconds simultaneously at state pressing power key. Then ✧ icon blinks. At this time, **B** icon blinks if press buzzer key. After press power key for five seconds, it enters to Standard Gas Calibration Mode. Initial concentration is 20%LEL.

Press power key to change value, and press buzzer key to save value. Calibration starts to setting concentration if press buzzer key at final number. For canceling calibration, press buzzer key.

Calibration is done for 20 seconds countdown. When calibration is successfully completed, **V** icon blinks and it appears concentration of standard gas. After this time, standard gas is not connected, it returns to Gas Measure Mode.

<Caution> As the calibration is conducted under the assumption that the concentration of oxygen in fresh air is 29.9% and that of flammable gas is 0%LEL and the same of toxic gas is 0ppm, the fresh air calibration must be conducted in fresh air where no influences of other gases are effective. Hence, it is not desirable conducting fresh air calibration in a closed space and should be very careful not to conduct under the working environment where gases can be inhaled by workers or operators.

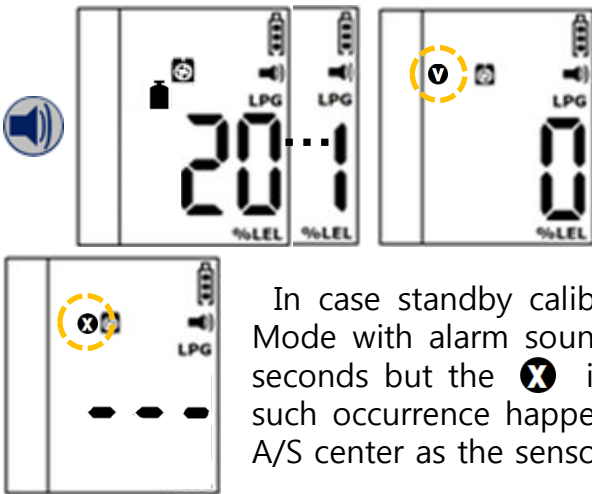

In case standby calibration is failed, it returns to Gas Measure Mode with alarm sound after the **X** icons being blinked for 3 seconds but the **X** icons shall remain appeared in this case. If such occurrence happens repeatedly, please contact our agent or A/S center as the sensor is required to be replaced.

Concentration of Calibration Gas Set to Instrument

Gas	Combustible gas	Hydrogen	Xylene
Concentration	20%LEL (1%vol CH ₄)	500 ppm	0.54%vol (Propane)

9. Method of Alarm Set and Display

Alarm Set

When power key and buzzer key is pressed for 3 seconds under the state of power OFF, **Warning!** icons shall appear blinking on LCD and indicates LO. Press power key one more time under this state to enter into alarm set mode. When power key is pressed at this point, system shall be entering into the 1st alarm change mode and, when buzzer key is pressed, HI shall be displayed on the monitor and then moves to the 2nd alarm set up mode. In order to return to Gas Measure Mode without changing alarm set value, use buzzer key to move.

After setting the 1st alarm value, returns to the 1st alarm set up mode that is the alarm mode initially set. Use arrow key to enter into the 2nd alarm set up mode or to return to Gas Measure Mode. Method of 2nd alarm set up is same as that of the 1st alarm setting.

While returning to Gas Measure Mode through the 2nd alarm set up mode, countdown shall be proceeded. When countdown is completed, system shall be converted to Gas Measure Mode.

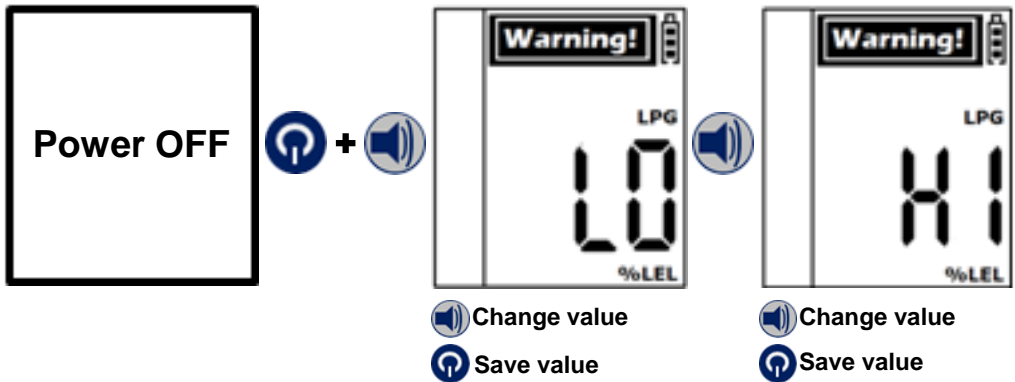

Alarm Display

In case 1st alarm is raised and power key is pressed by a worker or operator who perceived the status of 1st alarm, the alarm sound only shall be stopped but the device shall still remain in operation state. When 2nd alarm is raised, the workers should quickly escape from the work site to safe region. Termination of alarm in this case is possible only by turning power key Off at a place where gas concentration indicates normal value (Alarm shall be continuously raised unless the power key is turned off at an area of normal concentration value).









The alarm sound of 1st battery is same as that of the 1st alarm and, when power key is pressed, the alarm and vibration only shall be ceased but icons shall be kept blinking. The alarm sound of 2nd battery is same as that of 2nd alarm and the blink of icons can not be deleted by the users. The alarm and power shall be off 10 seconds after the raise of alarm.

In case of failure of test and calibration, icons shall blink with alarm sound.

Alarm Set Point

Gas	Combustible gas	Hydrogen	Xylene
1 st	20%LEL	100 ppm	20%LEL
2 nd	40%LEL	500 ppm	40%LEL

<Caution> The values set for alarm of the device are set in conformity with the alarming standards internationally required by gases. Therefore, the set value for alarm by gases can be modified by the approval of the manager responsible for the area where the device is used.

Alarm	Standard for Alarm	LCD Display	Alarm Sound
1 st Alarm	When exceeding the value set for 1 st alarm	Warning! and indicates LO	
2 nd Alarm	When exceeding the value set for 2 nd alarm	Warning! and indicates HI	
Low	One level only left unused	 Blinking Battery	
Dead	is exhausted	 Blinking Battery	
Test Failure	Failure of sensor test or calibration	Displays  icon	

8. Recharging



Recharging



End recharge

When adapter for recharge is equipped with the device, battery recharge mode shall be displayed on screen even under the mode of gas measure or power Off state. Power shall be Off when adapter is removed.

9. Replacement of Battery and Sensor

Following tools and parts are necessary to replace sensor and battery of SPsecure.

- Tool : + Driver
- Energizer No.E91, EN91 battery for replacement or rechargeable battery
- Sensor for replacement
- Sensor filter for replacement

<Caution>

1. No battery replacements or disassembly of product are permitted at potential explosion or dangerous area.
2. Please be noted that replacement of parts may cause damage to the fundamental safety capabilities of the device.
3. Sensors for replacement must be the one exclusively for SP Secure. The use of other sensors may cause problems in the detection of gas leakage or cause errors in the measurements.
4. The device is to be disassembled only for the replacement of battery or sensor and it has to be calibrated by utilizing standard gas during reassembly.

Disassembly

- Finish operation of the device.
- Replace sensor and battery referring to the picture below.
- Operate the device after replacing sensor and then adjust zero point and standardize the device.
- Conduct gas calibration (When battery only is replaced, standard gas calibration shall not be carried out)

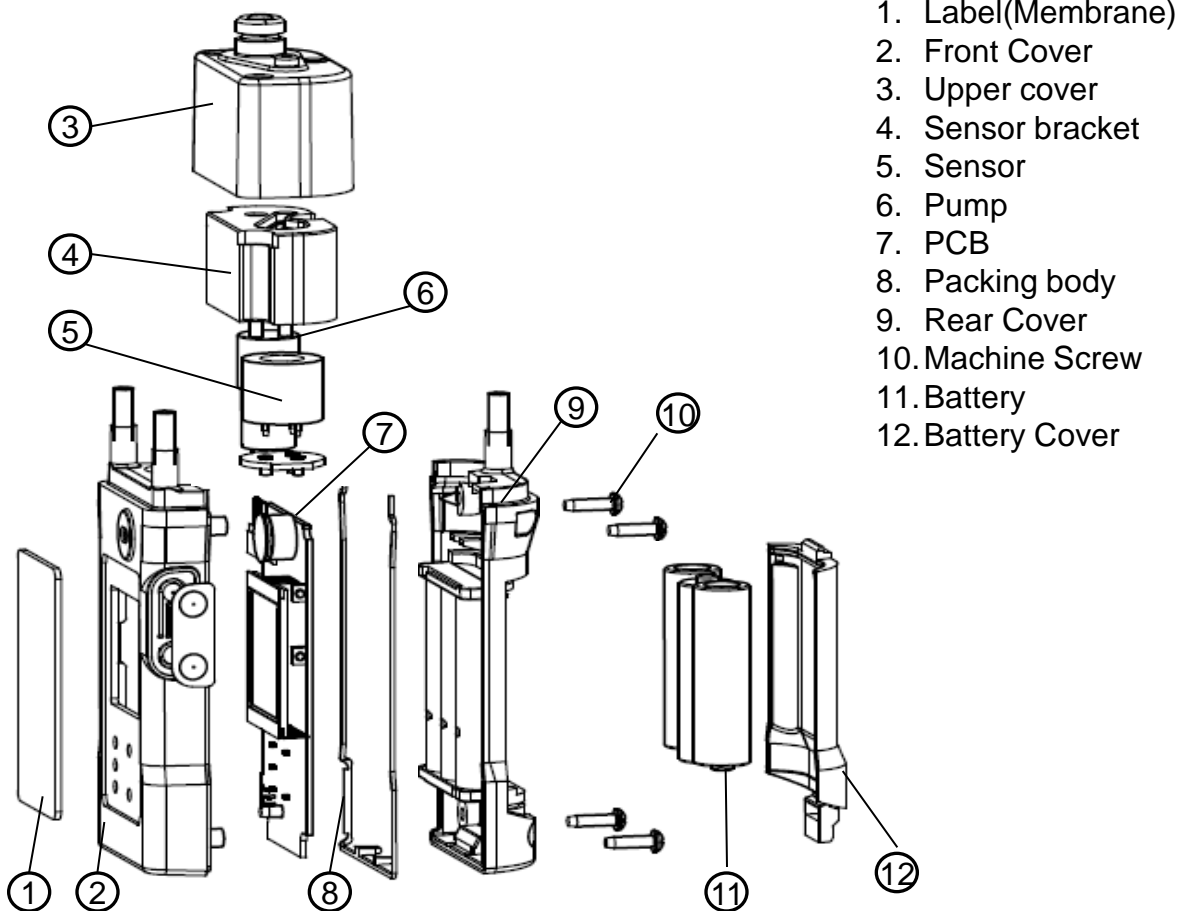

10. Applicable Battery

<Caution> It is absolutely prohibited to replace battery at potential explosion areas or dangerous regions. Specifications of the batteries applicable to this device are as follows.

- Disposable alkaline battery : Energizer No. E91, Energizer No.EN91
- Rechargeable battery : Panasonic Rechargeable BATTERY
HHR-3MRT, 1.2V

Batteries other than specified above are not allowed to use in dangerous area.

<Caution> Throwing battery into fire or disassembly by force may cause explosion. Disposal of used battery should be performed in accordance with the guideline of the pertinent country or the work site.

11. Notice for User

Please use the instrument in the range of the applicable temperature, humidity and pressure that are appropriate for the specification of the product. Using the instrument beyond this range may cause malfunction or glitch of the instrument. .

Gas concentration measurement value by the sensor or the instrument can vary according to the environment at site (temperature, pressure and humidity). Therefore the calibration of the instrument should be performed at the same or similar environment as that of the instrument use (temperature, pressure and humidity),

If temperature changes sharply during use of the instrument (for instance, using the instrument at places of far different temperatures between indoor and outdoor), the value of the measured gas concentration can be changed suddenly. Please use it after the gas concentration value is stabilized. .

Severe vibration or shock to the instrument may cause the sudden change of value of the measured gas concentration. Please use it after the value of gas concentration is stabilized. Excessive shock to the unit can lead to trouble of the sensor or the instrument.



제11-0350호

안 전 인 증 서

(주)세코

경기 안산시 단원구 원시동 768-5 반월하이테크빌리지 301,302,315호

위 사업장에서 제조하는 아래의 품목이 「산업안전보건법」 제34조 및 같은 법 시행규칙 제58조의4제4항에 따른 안전인증 심사 결과 안전·보건 기준에 적합하므로 안전인증표시의 사용을 인증합니다.

품 목

휴대용 가스 검지기

형식·모델 / 용량·등급 / 인증번호

형식·모델	용량·등급	인증번호
SPsecure	Ui=4.5 V Ex d ia IIB T3	11-GA2BO-0350X

인 증 기 준

방호장치 의무안전인증 고시(고용노동부고시 제2010-36호)

인 증 조 건

비위험 장소에서 배터리 교체 또는 충전할 것.
우레탄케이스와 함께 사용할 것.

2011년 12월 09일

한국가스안전공사 사장

