

LED Explosion-proof Light EP-02-G4



Better solutions for LED Explosion-proof Light

- IP66 water-proof**
- AC100-277V 50/60Hz**
- Easy Installation**
- 140lm/W**

Operating Temp.: -40°C ~ +50°C **Storage Temp.:** -40°C ~ +80°C

Options

Driver	Housing Color	CCT
Sosen Driver	Grey	3000K
	Orange	4000K
		5000K
		5700K

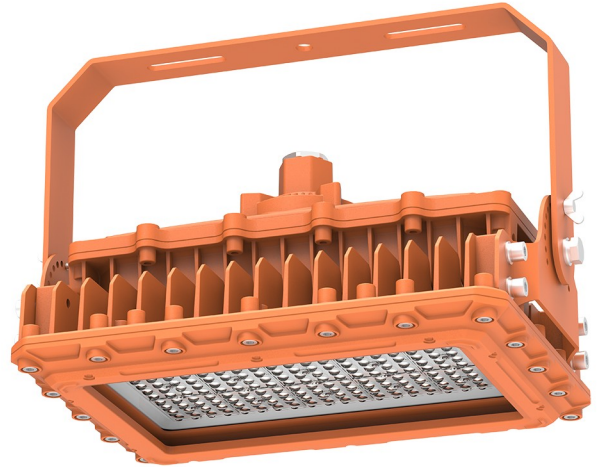

CLASSIFICATIONS & RATINGS

- Class I , Division 1 , Groups C , D
- Class I , Division 2 , Groups A , B , C , D
- Class II , Division 2 , Groups E , F , G
- Class III
- Zone 1,Group IIC
- Zone 2,Group IIC
- Zone 21,Group IIIC
- Zone 22,Group IIIC



II 2G Ex db IIC T6 Gb
II 2D Ex tb IIIC T80°C Db IP66

Application

The Explosion Proof Light can be widely used in Refineries,Fuel depots,Marine vessels,Chemical production processing,Food processing,Wineries, and otherhigh humidity,high temperature dusty places.

Specifications

Item	Power	Effi.	Leds	CRI	Weight	Beam Angle
EP120W-02-G4	120W	140lm/W	Lumileds	>80	10.30kg(22.7lbs)	30°/60°/90°/120°
EP150W-02-G4	150W	140lm/W	Lumileds	>80	10.30kg(22.7lbs)	30°/60°/90°/120°
EP180W-02-G4	180W	140lm/W	Lumileds	>80	10.30kg(22.7lbs)	30°/60°/90°/120°
EP200W-02-G4	200W	140lm/W	Lumileds	>80	10.30kg(22.7lbs)	30°/60°/90°/120°
EP240W-02-G4	240W	140lm/W	Lumileds	>80	10.30kg(22.7lbs)	30°/60°/90°/120°
EP400W-02-G4	400W	140lm/W	Lumileds	>80	23.50kg(51.8lbs)	30°/60°/90°/120°
EP500W-02-G4	500W	140lm/W	Lumileds	>80	23.50kg(51.8lbs)	30°/60°/90°/120°
EP800W-02-G4	800W	140lm/W	Lumileds	>80	43.20kg(95.2lbs)	30°/60°/90°/120°
EP1000W-02-G4	1000W	140lm/W	Lumileds	>80	43.20kg(95.2lbs)	30°/60°/90°/120°

Photometry

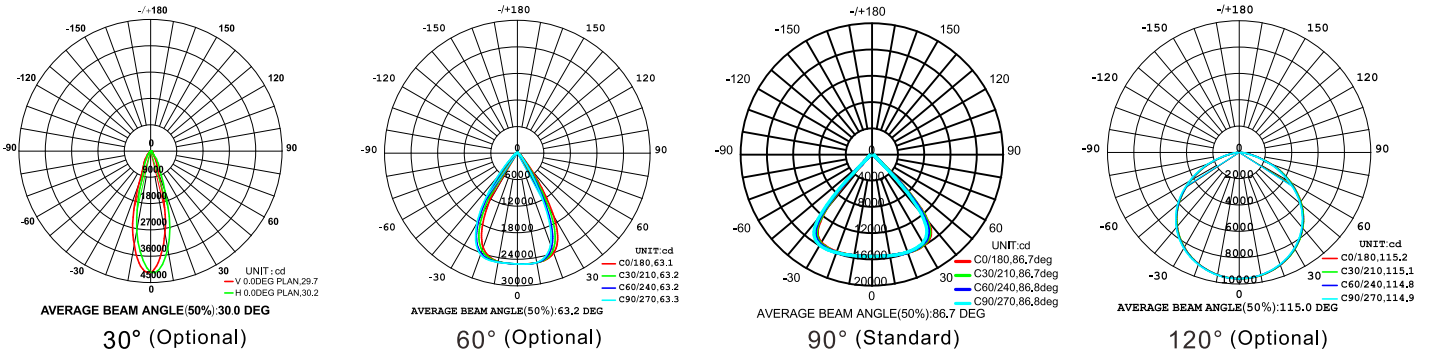

EP-02-G4 LED Explosion-proof Light

Dimensions(mm)

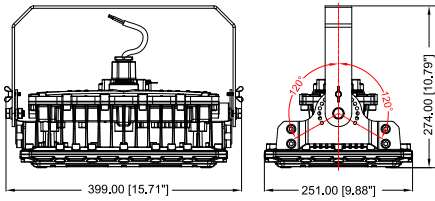

120W~240W-P1

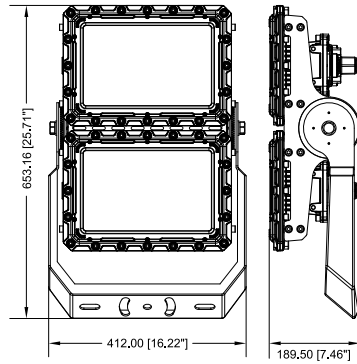

400W/500W-P1

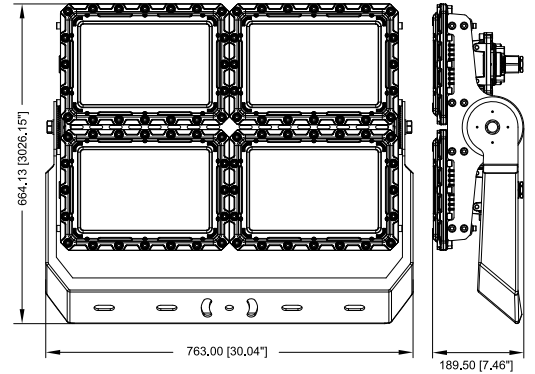

800W/1000W-P1

Model Options



120W~240W-P1

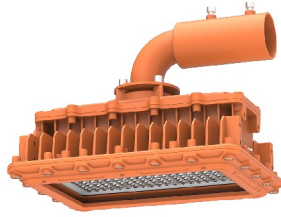

120W~240W-P2



120W~240W-P3



120W~240W-P4



400W/500W-P1

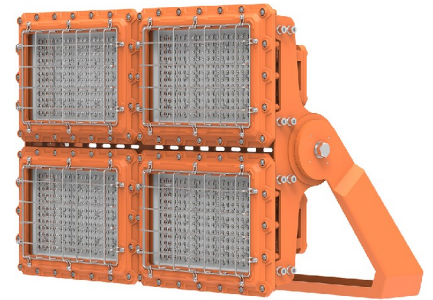

800W/1000W-P1

Installation and use

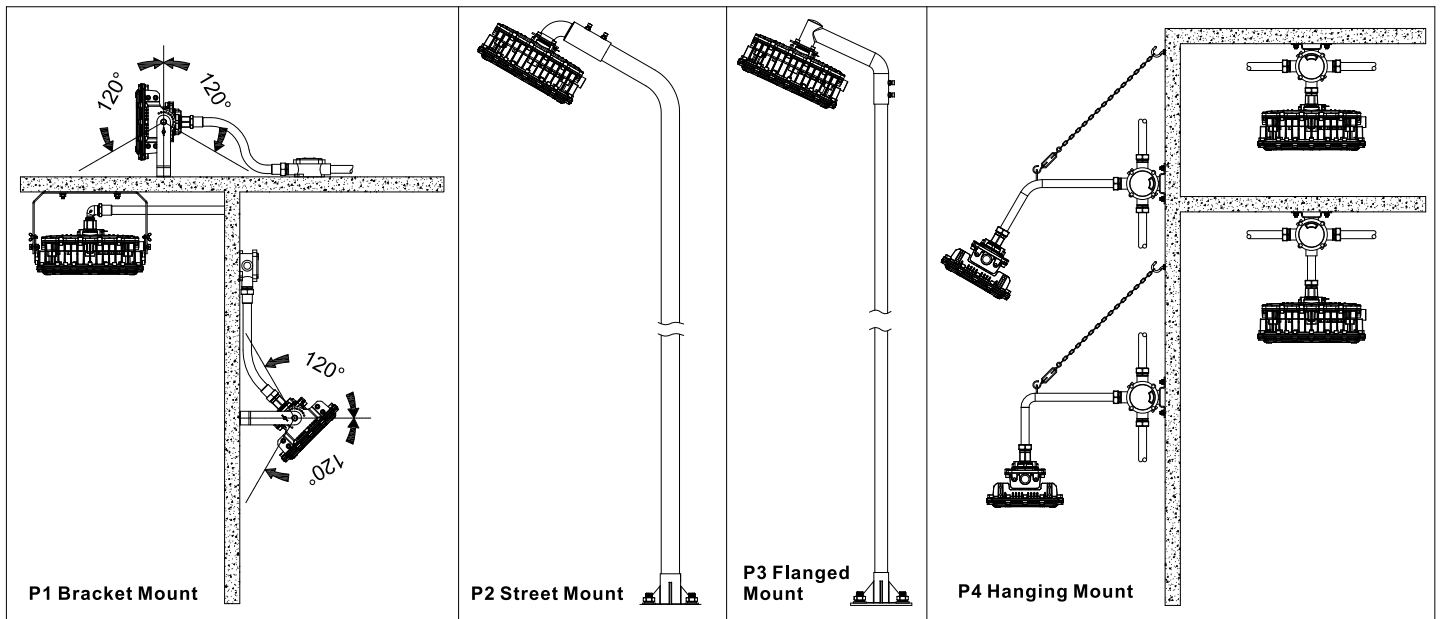

Packing Spec

Item	Box			Carton		
	Measurement(mm)	Gross weight	Pcs/box	Measurement(mm)	Gross weight	Pcs/box
EP120W~240W-02-G4-P1	L450*W380*H265	11.50kg(25.4lbs)	1	/	/	/
EP400W/500W-02-G4-P1	L770*W520*H310	23.50kg(51.8lbs)	1	/	/	/
EP800W/1000W-02-G4-P1	L880*W770*H310	46.7kg(103.0lbs)	1	/	/	/