





LED Explosion-proof Light EP-02-G5



Better solutions for LED Explosion-proof Light

-  **IP66 water-proof**
 -  **AC100-277V 50/60Hz**
 -  **Easy Installation**
 -  **140lm/W**
- Operating Temp.:** -40°C ~ +50°C **Storage Temp.:** -40°C ~ +80°C

Options

Driver	Housing Color	CCT
Sosen Driver	Grey Orange	3000K 4000K 5000K 5700K

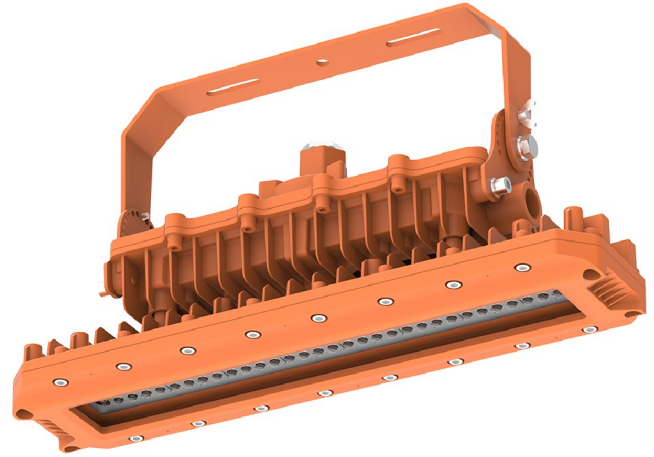

CLASSIFICATIONS & RATINGS

- Class I , Division 1 , Groups C , D
- Class I , Division 2 , Groups A , B , C , D
- Class II , Division 2 , Groups E , F , G
- Class III
- Zone 1,Group IIC
- Zone 2,Group IIC
- Zone 21,Group IIIC
- Zone 22,Group IIIC



II 2G Ex db IIC T6 Gb
II 2D Ex tb IIIC T80°C Db IP66

Application

The Explosion Proof Light can be widely used in Refineries, Fuel depots, Marine vessels, Chemical production processing, Food processing, Wineries, and other high humidity, high temperature dusty places.

Specifications

Item	Power	Effi.	Leds	CRI	Weight	Beam Angle
EP60W-02-G5	60W	140lm/W	Lumileds	>80	7.90kg(17.42lbs)	30°/60°/90°/120°
EP80W-02-G5	80W	140lm/W	Lumileds	>80	7.90kg(17.42lbs)	30°/60°/90°/120°
EP100W-02-G5	100W	140lm/W	Lumileds	>80	7.90kg(17.42lbs)	30°/60°/90°/120°
EP120W-02-G5	120W	140lm/W	Lumileds	>80	12.00kg(26.5lbs)	30°/60°/90°/120°
EP150W-02-G5	150W	140lm/W	Lumileds	>80	12.00kg(26.5lbs)	30°/60°/90°/120°
EP200W-02-G5	200W	140lm/W	Lumileds	>80	12.00kg(26.5lbs)	30°/60°/90°/120°

Photometry

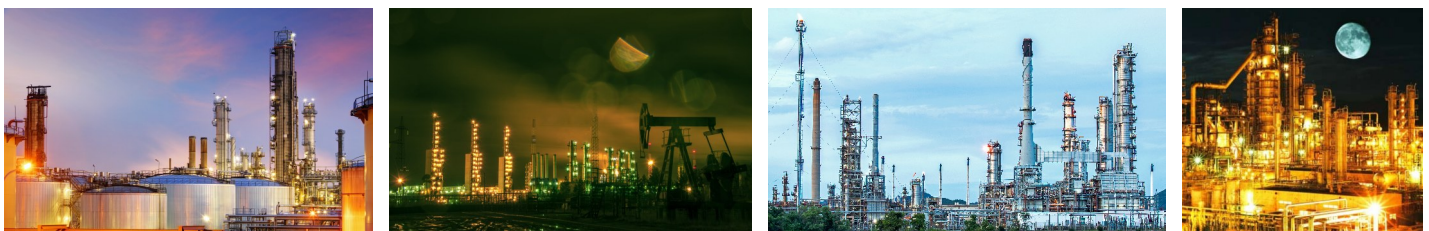
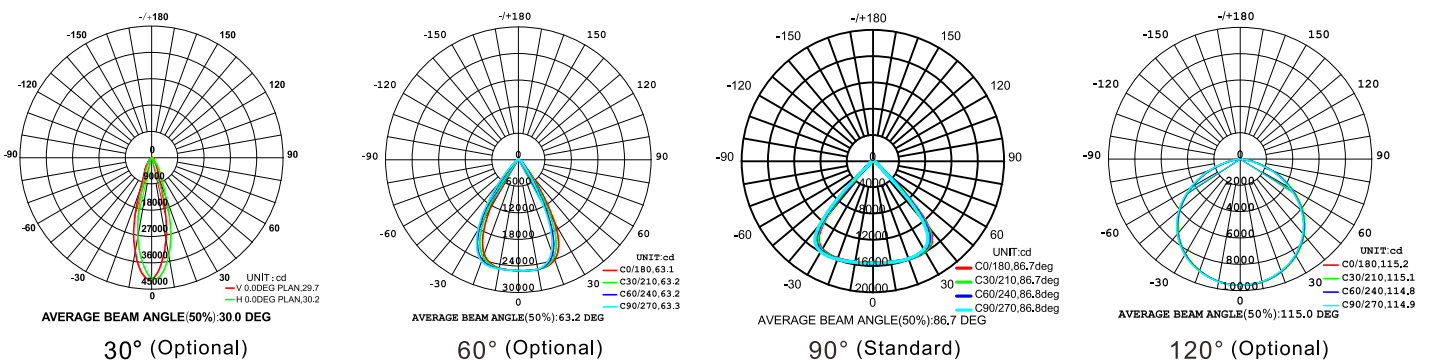

EP-02-G5

LED Explosion-proof Light



Dimensions(mm)

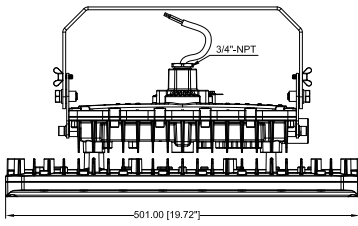

60W/80W/100W-P1

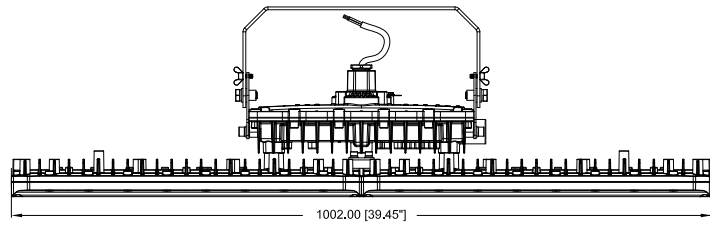
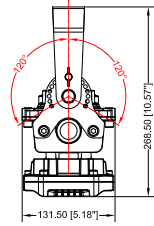

120W/150W/200W-P1

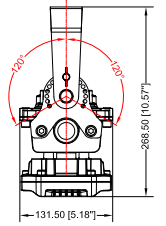

Model Options

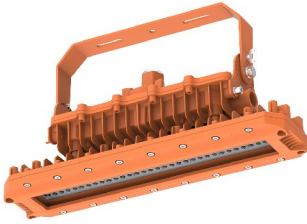

60W/80W/100W-P1

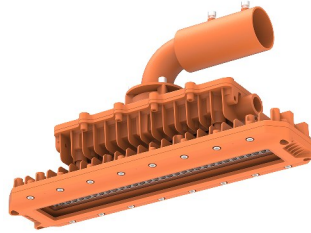

60W/80W/100W-P2



60W/80W/100W-P3

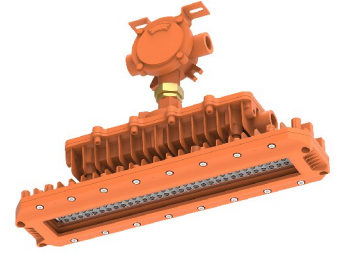

60W/80W/100W-P4

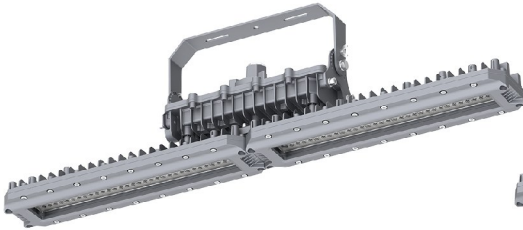

120W/150W/200W-P1

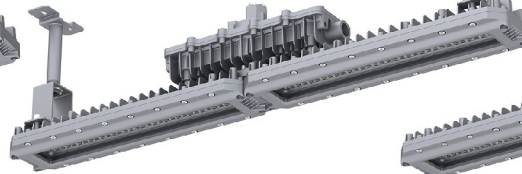

120W/150W/200W-P2

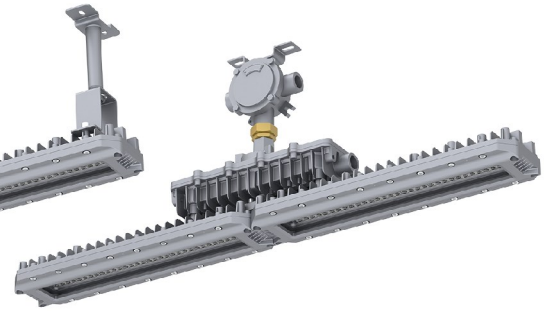

120W/150W/200W-P3

Installation and use

Single module

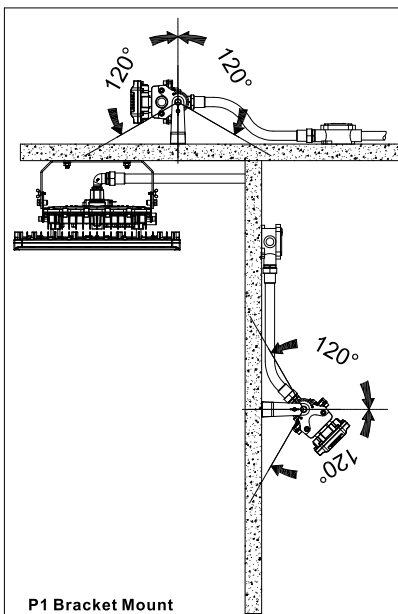

P1 Bracket Mount

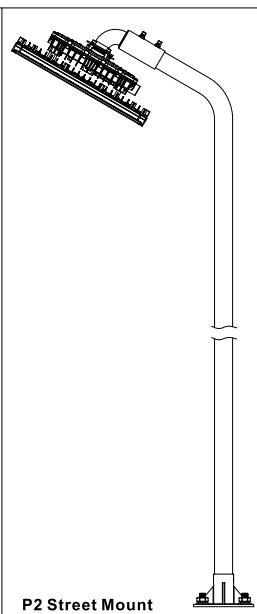

P2 Street Mount

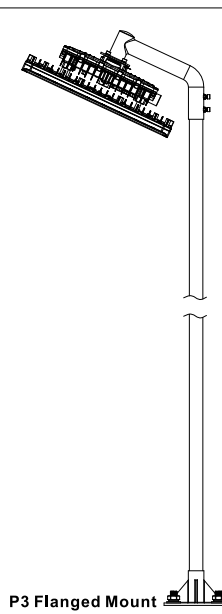

P3 Flanged Mount

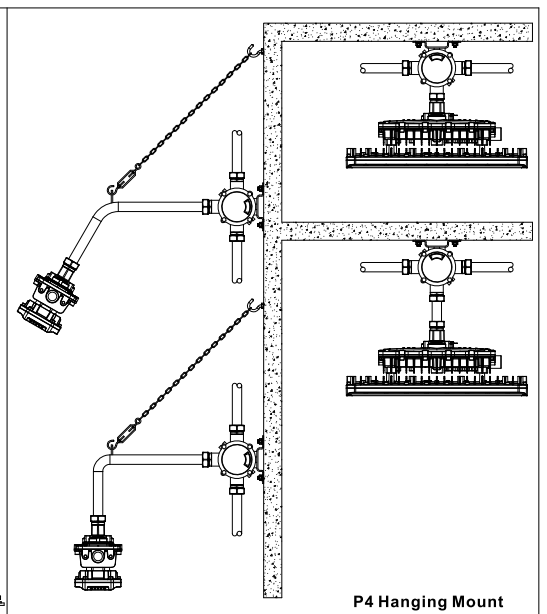

P4 Hanging Mount

EP-02-G5 LED Explosion-proof Light

Dual module

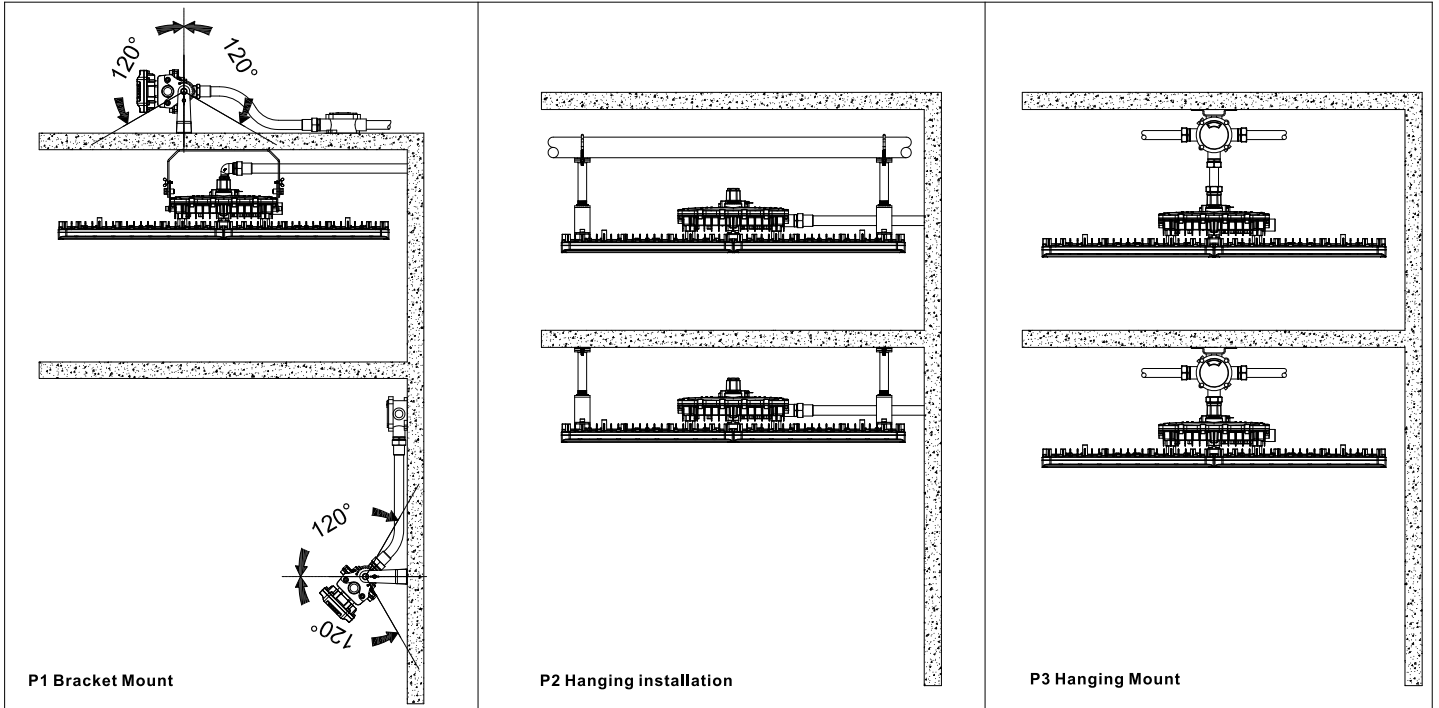

Packing Spec

Item	Box			Carton		
	Measurement(mm)	Gross weight	Pcs/box	Measurement(mm)	Gross weight	Pcs/box
EP60W/80W/100W-02-G5-P1	L570*W240*H255	9.40kg(20.7lbs)	1	/	/	/