

Empty Enclosures

BXT-□-W Series Explosion-proof Enclosures (Ex db IIB+H2)



- ◆ Explosion protection to
 - CENELEC
 - IEC
 - NEC
- ◆ Can be used in
 - Zone 1 and Zone 2
 - Zone 21 and Zone 22
 - Class I, Zone 1 and Zone 2
 - Class I, Division 1, Groups C, D
- ◆ Flameproof enclosure (Ex d IIB) in Copper-free Aluminium Alloy, formed of low pressure casting. 13 versions (external flange).
- ◆ Cable entries can be drilled and components can be installed by user on request.
- ◆ Safety shall be considered when installing components according to related electrical standards.
- ◆ Special requirements on request.

■ Catalogue number logic

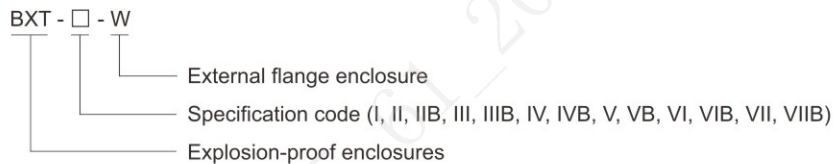

Zones 1&2; 21&22

Empty Enclosures

BXT-□-W Series Explosion-proof Enclosures (Ex db IIB+H₂)

Technical data	
Explosion-proof enclosures	BXT-□-W
Explosion protection	
Global (IECEX)	IECEX CQM 14.0011U
Gas and dust	Ex db IIB+H ₂ Gb Ex tb IIIC Db IP66
Europe (ATEX)	LCIE 11 ATEX 3012U
Gas and dust	⊕ II 2 G Ex db IIB+H ₂ Gb ⊕ II 2 D Ex tb IIIC Db IP66
Certificates	IECEX; ATEX; CU-TR
Conformity to standards	EN 60079-0, EN 60079-1, EN 60079-31 IEC 60079-0, IEC 60079-1, IEC 60079-31
Degree of protection	IP66
Internal & external earthing	I, II, IIB: M6/M6; III, IIIB, IV, IVB, V, VB, VI, VIB: M6/M8; VII, VIIB: M8/M8
Ambient temperature	-60°C~+100°C
Service temperature	-60°C~+200°C
Enclosure material	Copper-free Aluminium Alloy, powder coated surface, window grey (RAL7040)
Exposed fastener	Stainless steel
Mounting feet	Carbon steel, power coated surface
Hinge	With hinge

Selection table of BXT-□-W series explosion-proof enclosures (external flange)(all dimensions in mm)

Table of max. number of possible enclosure entries

Size	I		II		IIB		III		IIIB		IV		IVB	
	A/B	C/D	A/B	C/D	A/B	C/D	A/B	C/D	A/B	C/D	A/B	C/D	A/B	C/D
M20×1.5	5	8	5	10	5	12	10	12	16	20	12	16	22	30
M25×1.5	5	7	5	9	5	10	9	11	12	15	11	14	15	20
M32×1.5	2	3	2	4	2	6	7	9	9	12	9	12	12	16
M40×1.5	2	2	2	3	2	4	3	4	5	6	4	5	6	9
M50×1.5	1	2	1	3	1	3	3	3	4	5	3	4	5	7
M63×1.5	1	2	1	2	1	3	2	3	2	3	3	3	3	5
Size	V		VB		VI		VIB		VII		VIIB			
	A/B	C/D	A/B	C/D	A/B	C/D	A/B	C/D	A/B	C/D	A/B	C/D		
M20×1.5	14	21	24	40	20	35	30	50	30	40	45	65		
M25×1.5	12	19	18	27	18	30	20	36	26	36	30	44		
M32×1.5	10	15	14	21	15	26	18	30	20	30	25	36		
M40×1.5	4	7	8	12	8	13	11	18	10	16	15	21		
M50×1.5	4	5	5	9	6	11	6	10	8	12	12	12		
M63×1.5	3	5	4	7	3	5	5	9	4	6	7	10		

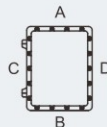
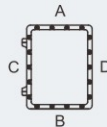

Empty Enclosures BXT-□-W Series Explosion-proof Enclosures (Ex db IIB+H2)

Selection table of BXT-□-W series explosion-proof enclosures (external flange)(all dimensions in mm)

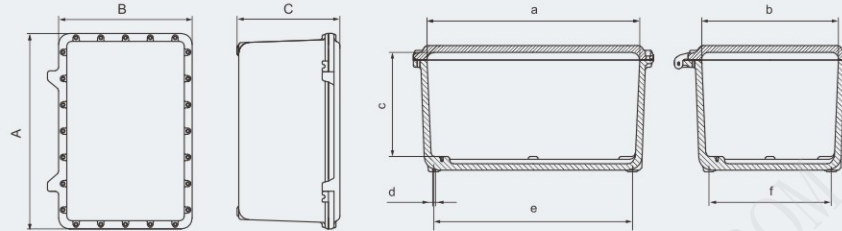

Enclosure

Version	Dimensions									Weight (kg)
	A	a	B	b	C	c	e	f	d	
BXT-I-W	250	192	200	142	170	131	180	130	M8	6.70
BXT-II-W	300	242	200	142	170	131	230	130	M8	8.00
BXT-IIB-W	350	292	200	142	170	131	280	130	M8	9.50
BXT-III-W	350	290	300	240	200	159	280	230	M10	14.50
BXT-IIIB-W	350	290	300	240	270	229	280	230	M10	17.50
BXT-IV-W	450	378	350	278	210	163	365	265	M10	23.00
BXT-IVB-W	450	378	350	278	280	233	365	265	M10	27.50
BXT-V-W	560	488	400	328	210	155	475	315	M10	34.50
BXT-VB-W	560	488	400	328	280	225	475	315	M10	39.50
BXT-VI-W	634	560	434	360	265	205	522	322	M10	46.00
BXT-VIB-W	634	560	434	360	335	275	522	322	M10	52.00
BXT-VII-W	720	640	560	480	275	215	620	460	M12	74.50
BXT-VIIB-W	720	640	560	480	345	285	620	460	M12	83.00

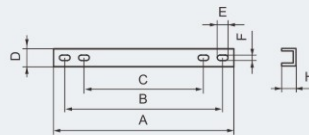

Mounting feet

Version	Dimensions						
	A	B	C	D	E	F	H
BXT-I-W	240	200	130	30	16	10	20
BXT-II-W	240	200	130	30	16	10	20
BXT-IIB-W	240	200	130	30	16	10	20
BXT-III-W	340	300	230	40	24	12	20
BXT-IIIB-W	340	300	230	40	24	12	20
BXT-IV-W	400	350	265	40	24	12	20
BXT-IVB-W	400	350	265	40	24	12	20
BXT-V-W	450	400	315	40	26	14	20
BXT-VB-W	450	400	315	40	26	14	20
BXT-VI-W	480	430	320	40	26	14	20
BXT-VIB-W	480	430	320	40	26	14	20
BXT-VII-W	620	560	460	50	26	14	20
BXT-VIIB-W	620	560	460	50	26	14	20



Empty Enclosures

BXT-□-W Series Explosion-proof Enclosures (Ex db IIB+H2)

Selection table of BXT-□-W series explosion-proof enclosures (external flange)(all dimensions in mm)

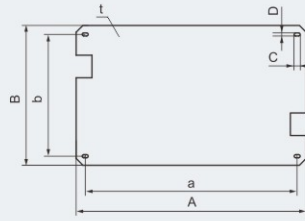

Mounting plate

Version	Dimensions						
	A	a	B	b	C	D	t
BXT-I-W	170	120	120	70	14	7	2
BXT-II-W	220	170	120	70	14	7	2
BXT-IIB-W	270	220	120	70	14	7	2
BXT-III-W	270	220	220	170	14	7	2
BXT-IIIB-W	270	220	220	170	14	7	2
BXT-IV-W	350	300	250	200	14	7	2
BXT-IVB-W	350	300	250	200	14	7	2
BXT-V-W	450	390	290	230	14	7	2
BXT-VB-W	450	390	290	230	14	7	2
BXT-VI-W	530	470	330	270	14	7	2
BXT-VIB-W	530	470	330	270	14	7	2
BXT-VII-W	600	550	440	390	14	7	2
BXT-VIIB-W	600	550	440	390	14	7	2



Empty Enclosures

BXT-□-W Series Explosion-proof Enclosures (Ex db IIB+H₂)



- ◆ Explosion protection to
 - CENELEC
 - IEC
 - NEC
- ◆ Can be used in
 - Zone 1 and Zone 2
 - Zone 21 and Zone 22
 - Class I, Zone 1 and Zone 2
 - Class I, Division 1, Groups C, D
- ◆ Flameproof enclosure (Ex d IIB) in Copper-free Aluminium Alloy, formed of low pressure casting. 2 versions (external flange).
- ◆ Cable entries can be drilled and components can be installed by user on request.
- ◆ Safety shall be considered when installing components according to related electrical standards.
- ◆ Professionally designed explosion-proof large enclosure provides space for more components.
- ◆ Adopting high-precision machining, excellent explosion-proof performance.
- ◆ Professionally designed door handles, reliable and safe when opening the door.
- ◆ Professionally designed hinges, reliable and safe when opening the door.
- ◆ Special requirements on request.

Catalogue number logic

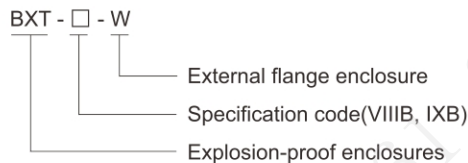

Technical data

Explosion-proof enclosures	BXT-□-W
Explosion protection	
Global (IECEX)	IECEX PCET 24.0029U
Gas and dust	Ex db IIB+H ₂ Gb Ex tb IIIC Db
Europe (ATEX)	TÜV CY 26 ATEX 0207554 U
Gas and dust	⊕ II 2 G Ex db IIB+H ₂ Gb ⊕ II 2 D Ex tb IIIC Db
Certificates	IECEX; ATEX
Conformity to standards	EN 60079-0, EN 60079-1, EN 60079-31 IEC 60079-0, IEC 60079-1, IEC 60079-31
Degree of protection	IP66
Internal & external earthing	M8/M8
Ambient temperature	-60°C~+100°C
Service temperature	-60°C~+160°C
Enclosure material	Copper-free Aluminium Alloy, powder coated surface, window grey (RAL7040)
Exposed fastener	Stainless steel
Mounting feet	Carbon steel, power coated surface
Hinge	With hinge

Zones 1&2; 21&22

Empty Enclosures

BXT-□-W Series Explosion-proof Enclosures (Ex db IIB+H2)

Selection table of BXT-□-W series explosion-proof enclosures (external flange)(all dimensions in mm)

BXT-VIIIIB, IXB-W

Table of max. number of possible enclosure entries

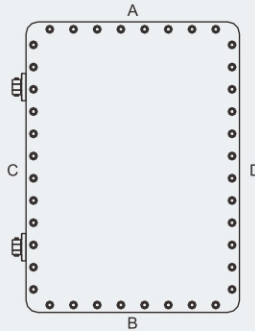

Type	A/B side		C/D side		Thread spec.
	Hole QTY	Hole distance range(mm)	Hole QTY	Hole distance range(mm)	
BXT-VIIIIB-W	28	60~70	44	60~70	NPT 1/2", M20×1.5, NPT 1/2", M25×1.5
	18	80~90	24	80~90	NPT 1", M32×1.5, NPT 1 1/4", M40×1.5
	8	110~120	12	110~120	NPT 1 1/2", M50×1.5, NPT 2", M63×1.5
	3	230~240	4	230~240	NPT 2 1/2", M75×1.5
	2	230~240	3	230~240	NPT 3", M90×1.5
	2	230~240	3	230~240	NPT 4", M115×1.5
BXT-IXB-W	45	60~70	70	60~70	NPT 1/2", M20×1.5, NPT 3/4", M25×1.5
	24	80~90	32	80~90	NPT 1", M32×1.5, NPT 1 1/4", M40×1.5
	15	110~120	24	110~120	NPT 1 1/2", M50×1.5, NPT 2", M63×1.5
	3	230~240	5	230~240	NPT 2 1/2", M75×1.5
	3	230~240	4	230~240	NPT 3", M90×1.5
	2	230~240	4	230~240	NPT 4", M115×1.5



Dimension drawings (all dimensions in mm) - subject to alteration

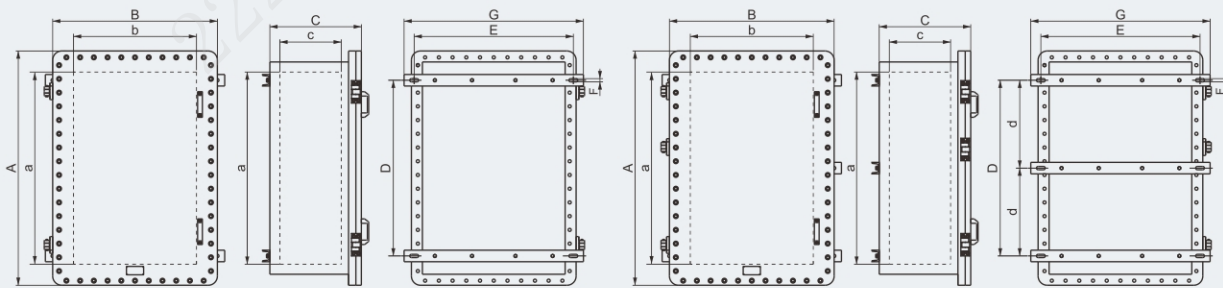

BXT-VIIIIB-W

BXT-IXB-W

Model	A	B	C	a	b	c	d	D	E	F	G
BXT-VIIIIB-W	980	720	425	800	540	270	-	830	700	14	750
BXT-IXB-W	1280	900	500	1050	670	330	540	1080	850	14	900

Empty Enclosures

BXT-□-C Series Explosion-proof Enclosures (Ex db IIC)

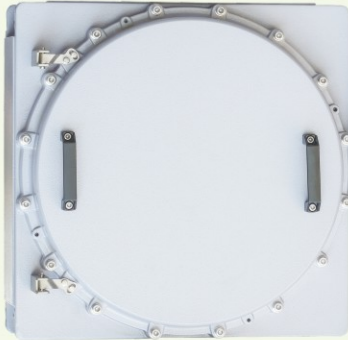

- ◆ Explosion protection to
 - CENELEC
 - IEC
 - NEC
- ◆ Can be used in
 - Zone 1 and Zone 2
 - Zone 21 and Zone 22
 - Class I, Zone 1 and Zone 2
 - Class I, Division 1, Groups C, D
- ◆ Flameproof enclosure (Ex db IIC) in Copper-free Aluminium Alloy, formed of low pressure casting.
- ◆ Cable entries can be drilled and components can be installed by user on request.
- ◆ Safety shall be considered when installing components according to related electrical standards.
- ◆ Professionally designed explosion-proof large enclosure provides space for more components.
- ◆ Adopting high-precision machining, excellent explosion-proof performance.
- ◆ Professionally designed door handles, reliable and safe when opening the door.
- ◆ Professionally designed hinges, reliable and safe when opening the door.
- ◆ Special requirements on request.

Catalogue number logic

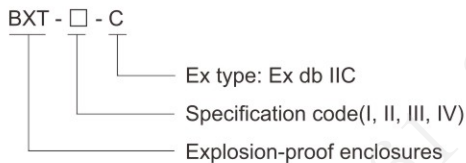

Technical data

Explosion-proof enclosures	BXT-□-C
Explosion protection	
Global (IECEX)	IECEX (applied for)
Gas and dust	Ex db IIC Gb
	Ex tb IIIC Db
Europe (ATEX)	ATEX (applied for)
Gas and dust	⊕ II 2 G Ex db IIC Gb
	⊕ II 2 D Ex tb IIIC Db
Certificates	IECEX; ATEX
Conformity to standards	EN 60079-0, EN 60079-1, EN 60079-31
	IEC 60079-0, IEC 60079-1, IEC 60079-31
Degree of protection	IP66
Internal&external earthing	M8/M8
Ambient temperature	-60°C~+200°C
Enclosure material	Copper-free Aluminium Alloy, powder coated surface, window grey (RAL7040)
Exposed fastener	Stainless steel
Mounting feet	Carbon steel, power coated surface
Hinge	With hinge

Zones 1&2; 21&22

Empty Enclosures

BXT-□-C Series Explosion-proof Enclosures (Ex db IIC)

Selection table of BXT-□-C series explosion-proof enclosures (all dimensions in mm)

Table of max. number of possible enclosure entries

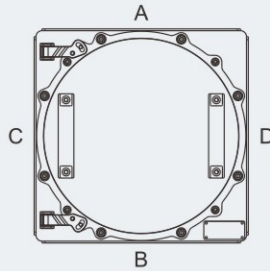

Type	A/B/C/D side		Thread spec.
	Hole QTY	Hole distance range(mm)	
BXT-I-C	8	50~60	NPT 1/2", M20×1.5, NPT 3/4", M25×1.5
	3	70~80	NPT 1", M32×1.5, NPT 1 1/4", M40×1.5
	2	90~100	NPT 1 1/2", M50×1.5, NPT 2", M63×1.5
	2	90~110	M42×2
BXT-II-C	14	50~60	NPT 1/2", M20×1.5, NPT 3/4", M25×1.5
	7	70~80	NPT 1", M32×1.5, NPT 1 1/4", M40×1.5
	3	90~100	NPT 1 1/2", M50×1.5, NPT 2", M63×1.5
	2	120~130	NPT 2 1/2", M75×1.5
BXT-III-C	4	90~100	M65×2
	18	50~60	NPT 1/2", M20×1.5, NPT 3/4", M25×1.5
	8	70~80	NPT 1", M32×1.5, NPT 1 1/4", M40×1.5
	5	90~100	NPT 1 1/2", M50×1.5, NPT 2", M63×1.5
BXT-IV-C	2	120~130	NPT 2 1/2", M75×1.5
	21	50~60	NPT 1/2", M20×1.5, NPT 3/4", M25×1.5
	10	70~80	NPT 1", M32×1.5, NPT 1 1/4", M40×1.5
	7	90~100	NPT 1 1/2", M50×1.5, NPT 2", M63×1.5
	3	120~130	NPT 2 1/2", M75×1.5



Dimension drawings (all dimensions in mm) - subject to alteration

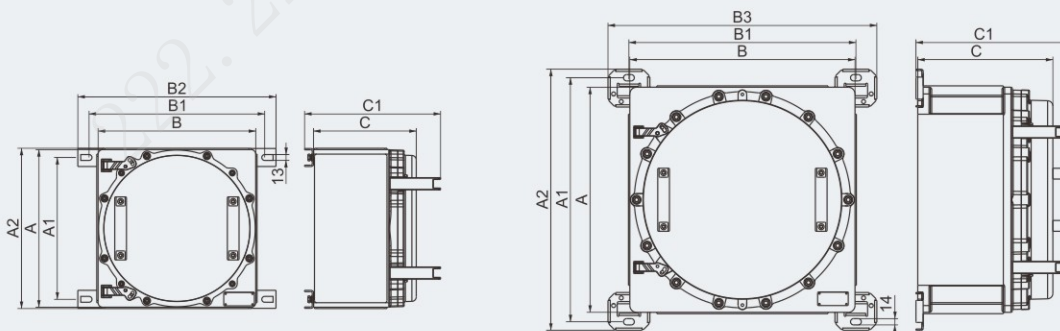

Model	Version	Dimension (mm)							
		A	B	C	A1	A2	B1	B2	C1
BXT-I-C	250×250	250	250	168	212	252	290	340	188
BXT-II-C	350×350	250	250	228	315	356	190	440	188
BXT-III-C	500×500	500	500	300	542	580	504	597	344
BXT-IV-C	600×600	600	600	300	642	680	604	697	344

Note: For cable entries:

- 1). Please specify the direction and size of each cable entry.
- 2). Cable gland is optional, DQM-II (Ex d) or DQM-III (Ex d) is recommended, please see P6/24~39.

Empty Enclosures

BXT-e Series Increased Safety Enclosures (Ex e IIC)



- ◆ Explosion protection to
 - CENELEC
 - IEC
 - NEC
- ◆ Can be used in
 - Zone 1 and Zone 2
 - Zone 21 and Zone 22
 - Class I, Zone 1 and Zone 2
 - Class I, Division 2, Groups A, B, C, D
- ◆ Copper-free Aluminium Alloy enclosure (Ex e IIC), 8 versions.
- ◆ Cable entries can be drilled and components can be installed by user on request.
- ◆ Safety shall be considered when installing components according to related electrical standards.
- ◆ Special requirements on request.

Catalogue number logic

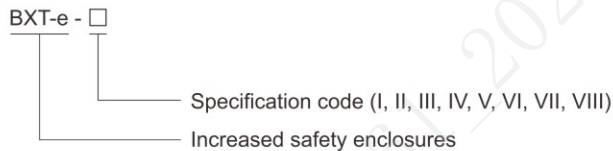

Technical data

Increased safety enclosures	BXT-e-□
Explosion protection	
Global (IECEX)	IECEX CQM 13.0036U
Gas and dust	Ex e IIC Gb Ex tb IIIC Db IP66
Europe (ATEX)	LCIE 13 ATEX 3053X
Gas and dust	⊕ II 2 G Ex e IIC Gb ⊕ II 2 D Ex tb IIIC Db IP66
Certificates	IECEX; ATEX
Conformity to standards	EN 60079-0, EN 60079-7, EN 60079-31 IEC 60079-0, IEC 60079-7, IEC 60079-31
Degree of protection	IP66
Internal & external earthing	M6/M6
Ambient temperature	-60°C~+100°C
Enclosure material	Copper-free Aluminium Alloy, powder coated surface, window grey (RAL7040)
Exposed fastener	Stainless steel

Zones 1&2; 21&22

Empty Enclosures

BXT-e Series Increased Safety Enclosures (Ex e IIC)

Selection table of BXT-e series increased safety enclosures (all dimensions in mm)

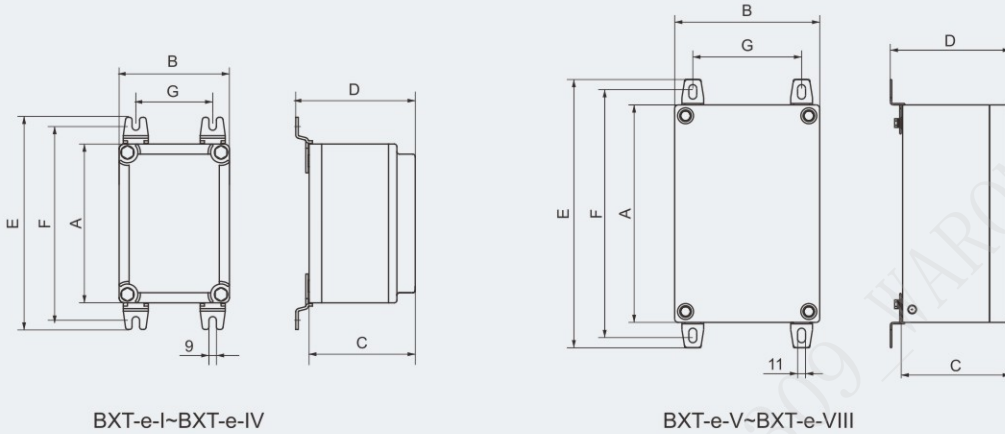

Outline & Installation

Version	Outline dimensions				Installation dimensions		
	A	B	C	D	E	F	G
BXT-e-I	190	132	128	143	252	232	92
BXT-e-II	190	190	128	143	252	232	150
BXT-e-III	250	190	128	143	312	292	150
BXT-e-IV	250	250	128	143	312	292	210
BXT-e-V	300	190	151	164	370	342	150
BXT-e-VI	300	280	151	164	370	342	250
BXT-e-VII	350	250	151	164	420	392	200
BXT-e-VIII	502	350	151	164	572	544	300

Note: Other dimensions on request

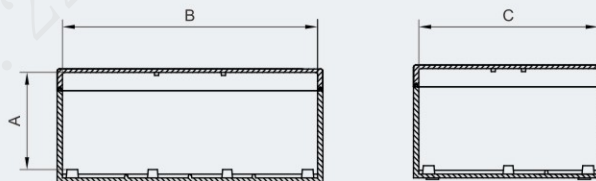

Internal

Version	Dimensions			Weight (kg)
	A	B	C	
BXT-e-I	108	177	120	2.40
BXT-e-II	107	177	177	2.80
BXT-e-III	107	237	177	3.80
BXT-e-IV	107	235	235	5.10
BXT-e-V	130	286	179	5.80
BXT-e-VI	130	286	269	7.10
BXT-e-VII	130	336	236	7.00
BXT-e-VIII	130	488	336	9.50

