

Operating Instructions



Bluetooth Handheld Scanner
iSCAN2012D
iSCAN211
iSCAN211PDF

Revision date: 5.10.2016



Contents

| | | |
|-----|---|----|
| 1. | iSCAN2x1 product range overview | 3 |
| 2. | Important notes on the operating instructions | 4 |
| 2.1 | Safety information | 4 |
| 2.2 | Notes on the operating instructions | 4 |
| 2.3 | General notes of caution | 5 |
| 3. | Product Information | 7 |
| 3.1 | Manufacturer | 7 |
| 3.2 | Certification..... | 7 |
| 3.3 | Serial numbers | 7 |
| 3.4 | Technical data for base/charging station..... | 8 |
| 4 | System assembly..... | 9 |
| 4.1 | Assembly 1 description | 9 |
| 4.2 | Cable range in assembly 1..... | 10 |
| 4.3 | Assembly 2 description | 10 |
| 4.4 | Cable range in assembly 2..... | 11 |
| 5 | Step by step guide to installation and operation..... | 12 |
| 5.1 | General connection of handheld scanner..... | 12 |
| 5.2 | Using the base station in hazardous areas (assembly 1) | 13 |
| 5.3 | Using the base station in non-hazardous areas (assembly 2)..... | 14 |
| 5.4 | Connection of RS232 iSCANPS power supply | 15 |
| 5.5 | Connection of USB iSCANPS power supply..... | 17 |

Revision control

Document Number **416238, revision 3.1**

© This document is copyright Extronics Limited 2016.

Extronics reserve the right to change this document and its content without notice. The latest version applies.



1. iSCAN2x1 product range overview

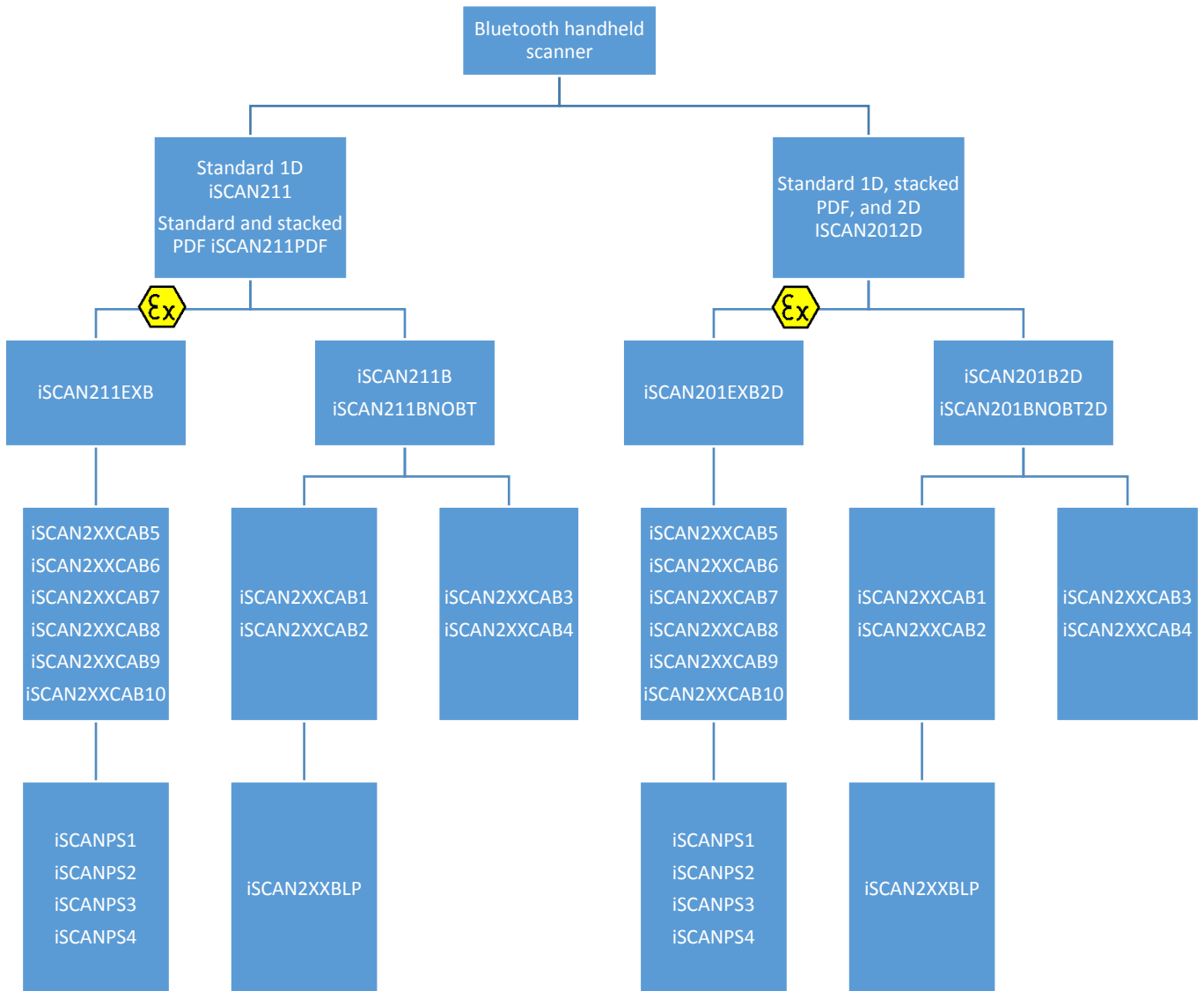

2. Important notes on the operating instructions

2.1 Safety information

Warnings are highlighted by a special symbol and a different font colour:



Danger

**Non-compliance may result in life-threatening situations.
This warning must be heeded.**



Warning

This type of warning concerns dangerous situations that may result in minor injuries.



Info

Important and helpful notes and information.

2.2 Notes on the operating instructions

Before starting up the equipment please read the Manual thoroughly.

The Operating Instructions contain important information on functionality as well as safety rules. If these are not heeded, normal operations within hazardous areas cannot be guaranteed.

The notes contained in this manual are important for starting up and operating the product.

These instructions may be updated at any time. Extronics Limited reserves the right to make changes to this document. Before they use the product, users must ensure that they have the most up-to-date version of the operating instructions. To make sure this is the case, please check Extronics' website, www.extronics.com, or contact one of the company's staff.

The drawings contained in these operating instructions are for illustration purposes only and may differ somewhat from the actual design.



No changes may be made to the device that were not intended or approved by Extronics Limited.



If the handheld scanner is not used properly, the operating permission for hazardous areas may lapse for the device in question.

Non-adherence to the instructions will void any warranty.



For the full commission of the handheld scanner, the programming information contained in the manual issued by SICK AG (www.SICK.com) is also required.

2.3 General notes of caution

Caution / Notes



- The devices may only be operated when fully assembled.
- In hazardous areas, the devices must not be wiped or cleaned with a dry cloth.
- The device must be switched off immediately if it is likely that it can no longer be operated safely as a result of damaging impact or general peculiarities (such as ingress of water or other fluids, temperatures outside of the specified range, etc.).
- General statutory requirements or health and safety rules and accident prevention guidelines and environmental laws must be adhered to (e.g. the German Occupational Health and Safety regulation).
- Users must not open the device.
- Users must not make any changes to the device. Components may not be exchanged or replaced. If non-specified components are used, explosion protection is no longer guaranteed.
- Ensure safe handling with firm footing and sufficient room for movement.
- If the enclosure is in any way damaged the device must be removed from the hazardous area immediately.
- In accordance with IEC 60079-19 and IEC 60079-17, operators of electrical installation in hazardous areas are obliged to have them serviced by qualified electricians.
- Do not insert any sharp objects into the enclosure or any other openings of the handheld barcode scanner. Any openings at the device may not be covered or blocked.
- The device and any accessories must be properly disposed of, i.e. as legally specified, for example by a certified company.



Notes on installation

- Electrical plants are subject to certain regulations concerning installation and operation (e.g. RL 99/92/EG, RL 94/9EG, or the national rules such as IEC 60 079-14 and VDE 0100).
- In the hazardous area it is the operator's responsibility to carry out any repair and maintenance in compliance with applicable rules.

Caution on laser devices



Devices fitted with laser fall under standards US 21 CFR 1040.10 and EN 60825-1. The laser's classification is stated on a plate affixed to the device. Class 1 lasers are deemed inherently safe during normal use, but users must not look directly into the light source. The following declaration is required by American and international laws:

Usage of control elements, adaptations or the use of procedures that differ from these instructions may result in a dangerous exposure to laser beams. Class 2 lasers use a visible low-voltage LED. As with any source of bright light, such as the sun, the user should avoid looking directly into the light. Brief exposure to a class 2 laser is deemed not dangerous.

Maintenance

Provided the device is operated and assembled according to instructions and the ambient requirements are being met continuous maintenance is not necessary.

Servicing

Operators of electric equipment in hazardous areas are obliged to have them serviced by qualified electricians (IEC 60079-19 and IEC 60079-17).

Repairs

Repairs may only be carried out by the manufacturer or by persons trained and commissioned for this purpose by the manufacturer.

The device is closed ex-factory. It may only be opened in the factory by specifically trained personnel.

Software installation

For instructions on how to install the software at the PC please refer to the manual issued by SICK.

Operation

Before operating the device you must ensure that all necessary components are available.



3. Product Information





3.1 Manufacturer

Extronics Limited
1 Dalton Way
Midpoint 18
Middlewich
CW10 0HU







3.2 Certification

**iSCAN211 and
iSCAN211PDF:**

-  II 2 G Ex ib IIC T4
-  II 2 G Ex ib IIC T4 Gb
-  II 2 D Ex ib IIC T135°C
-  II 2 D Ex ib IIC T135°C Db

iSCAN2012D:

-  II 2G Ex ib IIB T4
-  II 2G Ex ib IIB T4 Gb
-  II 2D Ex ib IIC T135°C
-  II 2D Ex ib IIC T135°C Db

Test certificate IBExU15ATEX1084
 IECEX IBE 15.0024

Protection rating IP65

3.3 Serial numbers

| Serial key: | Year of manufacture (2 numbers) | Serial number (4 numbers) |
|-------------|------------------------------------|------------------------------|
| Example: | 16 | 0001 |



3.4 Technical data for base/charging station

Nominal values of hazardous area base station:

- maximum input voltage U_i 4.9 V
- maximum input current I_i 480 mA
- maximum input power P_i 1.25 W
- maximum internal inductance L_i negligible
- maximum internal capacitance C_i 112.4 μ F

If using a power supply other than iSCANPSx:

- maximum input voltage U_i 5.6 V
- maximum input current I_i 480 mA
- maximum input power P_i 1.25 W
- maximum internal inductance L_i negligible
- maximum internal capacitance C_i 46 μ F

Note: The input voltage in to the handheld scanner itself is reduced by the associated connection cable iSCAN2XXCAB7 or 8 to 4.9V.

Nominal values of safe area base station:

- operating voltage U 5V
- power requirement I 85 mA in standby mode

Ambient temperature for base station: -20°C to +50°C

Bluetooth: Bluetooth V4.0 EDR, Class 1
2.4...2.4835 GHZ (ISM band)

Terminal assignment (Handheld scanner)

USB cable

- USB/D+ green
- USB/D- white
- GND black
- +UB brown

RS232 cable

- RS232-TXD white
- GND brown
- +UB yellow



4 System assembly

4.1 Assembly 1 description

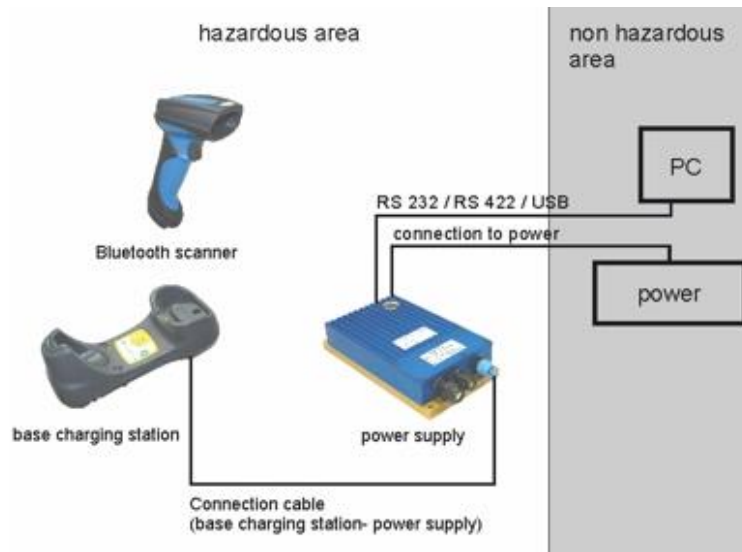

The Bluetooth handheld scanner was designed for use in hazardous areas. Normal operation requires a base station, a connection cable between base station and power supply, power supply, and connection cable(s) between power supply and a PC.

External connection cables:

- Data cable:** USB 0.2 - 2.5 mm², 4-wire
RS232 0.2 - 2.5 mm², 3-wire
- Power cable:** 0.2 - 2.5 mm², 3-wire

The handheld scanner and the power supply can be connected and operated in the hazardous area. For safe installation please refer to the manual issued by SICK AG (www.SICK.com)







The warnings and notes of caution contained in these operating instructions and in the manual issued by SICK AG (www.SICK.com) must be adhered to.



For the professional use of the power supply iSCANPS the operating instructions of the manual of the power supply are necessary.



4.2 Cable range in assembly 1

| | | | | |
|--------------|---|---|---|---|
| |  |  |  |  |
| RS232 | iSCAN211EXB iSCAN201EXB2D | 1.8 or 3.8m or optional with 4.5m or 6m extension | iSCANPS | Up to 20m Host |
| USB | iSCAN211EXB iSCAN201EXB2D | 1.8 or 3.8 m | iSCANPS | Up to 5m Host |

4.3 Assembly 2 description

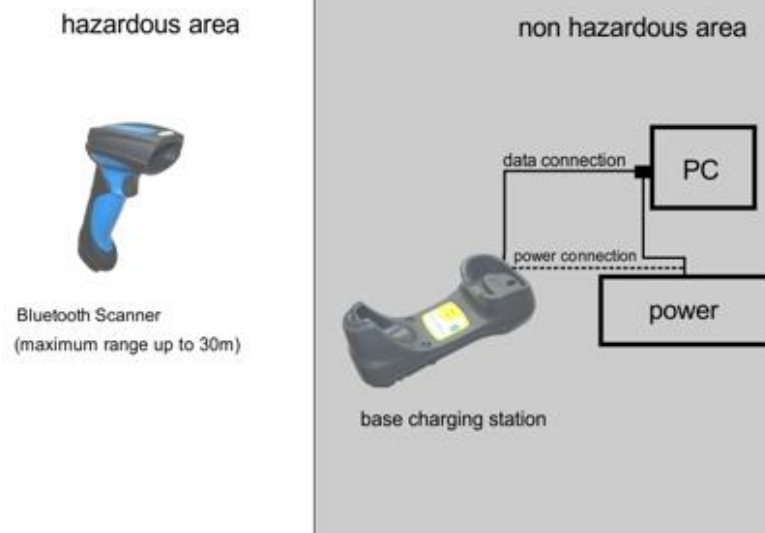

The Bluetooth handheld scanner can also be used separately in the hazardous area. The base or charging station is then operated in the non-hazardous area.

Use an RS232 cable (iSCAN2XXCAB1 or 2) or a USB cable (iSCAN2XXCAB3 or 4) to connect the station directly to a power supply and a PC.



The warnings and notes of caution contained in these operating instructions and in the manual issued by SICK AG (www.SICK.com) must be adhered to.











4.4 Cable range in assembly 2

| | | | | |
|--------------|---|---|--|---|
| |  |  | |  |
| RS232 | iSCAN211B iSCAN211BNOBT iSCAN201B2D iSCAN201BNOBT | 1.8 or 3.8m or optional with 4.5m or 6m extension |  | Host |
| USB | iSCAN211B iSCAN211BNOBT iSCAN201B2D iSCAN201BNOBT | 1.8 or 3.8 m |  | Host |







5 Step by step guide to installation and operation

5.1 General connection of handheld scanner

| | |
|---|---|
|  | <p>Do not replace the battery in hazardous areas.</p> <p>Incorrect handling may result in the termination of the operating permit.</p> |
|  | <p>The battery compartment is located at the bottom of the Bluetooth handheld scanner. Loosen the screw to remove the lid.</p> |
|  | <p>Open the battery compartment.</p> <p> After the screw has been loosened, the removal of the lid requires a certain amount of force.</p> |
|  | <p>An iSCAN2XXBATT is required to operate the Bluetooth handheld scanner.</p> <p> Use only this battery for the Bluetooth scanner.</p> <p>Before placing the battery inside the scanner, remove its protective cap.</p> |
|  | <p>Insert the battery into the battery compartment of the scanner. The end of the removal strap must protrude from the opening.</p> <p> If the battery has been correctly inserted and connected to the contacts, this will be indicated by an acoustic and a visible signal.</p> <p>Close the compartment. Check that the screw has been tightened properly.</p> |









5.2 Using the base station in hazardous areas (assembly 1)

| | |
|---|--|
|  | <p>The device has been closed ex-factory.</p> <p>Incorrect handling may result in the termination of the operating permit.</p> |
|  | <p>The cable connecting the base charging station to the power supply is iSCAN2XXCAB5, 6, 7, 8, 9 or 10.</p> |
|  | <p>Insert the cable in the opening at the bottom of the base charging station.</p> <p>i If the cable has been inserted fully you can hear a "click". Check if the cable fits firmly.</p> |
|  | <p>Insert the plug of the connection cable into the power supply's plug connector.</p> <p>i Ensure that the connection is fully secured with the screw cap after the plug has been inserted.</p> |
|  | <p>Place the Bluetooth handheld scanner onto the charging station. Insert the lower part of the handle to ensure that the contacts for charging are connected properly.</p> <p>i The LED at the head of the scanner will come on to indicate successful charging.</p> |



5.3 Using the base station in non-hazardous areas (assembly 2)

| | |
|---|---|
|  | <p>Charge the handheld scanner in the safe area with a non-explosion-protected base charging station. Use a safe area power supply for supply to the base charging station.</p> <p>The cable is inserted in the corresponding opening at the bottom of the base charging station.</p> <p> This connection is closed ex-factory for a base charging station for hazardous areas.</p> |
|  | <p>To connect the base charging station in a non-hazardous area, the connection cable for the power supply and the PC is inserted in the opening at the bottom of the base charging station. Use iSCAN2XXCAB1, 2, 3 or 4.</p> <p> If the cable has been inserted fully you can hear a "click". Check that the cable fits firmly.</p> |
|  | <p>Place the handheld scanner onto the charging station. Insert the lower part of the handle to ensure that the contacts for charging are connected properly.</p> <p> The LED at the head of the scanner will come on to indicate successful charging.</p> |





5.4 Connection of RS232 iSCANPS power supply

Supply of the base station as per assembly 1 with plug connection:



The terminal assignment is located underneath the removable cover at the front of the power supply.

 **Caution: Do not open enclosure in the hazardous area.**
Before operating the device in a hazardous area you have to ensure that the enclosure has been closed fully and all screws have been tightened.

 **Cables may only be connected by trained staff.**

Connection of base station to the RS232 power supply with plug connection:



| RS232 cable | | Power supply | | | |
|------------------------------------|------------|-----------------------------------|------|----------------|--------|
| Pin assignment connection coupling | | Pre-assembled Connection coupling | | Connection box | |
| Pin | Definition | Pin | Wire | Definition | Number |
| 3 | TxD | 3 | 3 | RxD | X9 |
| | | | | GND | X10 |
| | | | | PE | X11 |
| 2 | GND | 2 | 2 | GND | X12 |
| 1 | +UB | 1 | 1 | +UB | X13 |



Direct connection of base station without plug connection to the RS232 iSCANPS – connection with cable end sleeve:

| Pin assignment of scanner | RS232 connection cable | | | Power supply | |
|---|------------------------|--------------|------------|----------------------------------|------------|
| | RJ45 Pin assignment | Wire colours | Definition | Connection terminal power supply | Definition |
|  | 6 | White | TXD | X9 | RXD |
| | | | | X10 | GND |
| | | | | X11 | PE |
| | 4 | Brown | GND | X12 | GND |
| | 7 | Yellow | +UB | X13 | +UB |
| | | | | | |

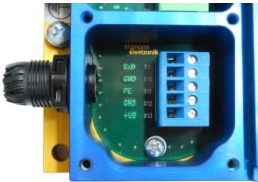
| | |
|---|--|
|  | <p>Intrinsically safe connection box of the RS232 iSCANPS power supply after removal of the wires of the plug connection</p> |
|---|--|



To fully operate the Bluetooth handheld scanner you will require the programming information contained in the manual published by SICK AG (www.SICK.com).





5.5 Connection of USB iSCANPS power supply

Supply of the base station as per assembly 1 with plug connection:



The terminal assignment is located underneath the removable cover at the front of the power supply.

 **Caution: Do not open enclosure in the hazardous area.**
Before operating the device in a hazardous area you have to ensure that the enclosure has been closed fully and all screws have been tightened.

 **Cables may only be connected by trained staff.**

Connection of base station to the USB power supply with plug connection:



| USB cable | | Power supply | | | |
|------------------------------------|------------|-----------------------------------|------|----------------|--------|
| Pin assignment connection coupling | | Pre-assembled Connection coupling | | Connection box | |
| Pin | Definition | Pin | Wire | Definition | Number |
| 3 | D+ | 3 | 3 | D+ | X9 |
| 2 | D- | 2 | 4 | D- | X10 |
| | | | | PE | X11 |
| 4 | GND | 4 | 2 | GND | X12 |
| 1 | +UB | 1 | 1 | +UB | X13 |



Direct connection of base station without plug connection to the RS232 iSCANPS – connection with cable end sleeve:

| Pin assignment of scanner | USB connection cable | | | Power supply | |
|---|----------------------|--------------|------------|----------------------------------|------------|
| | RJ45 Pin assignment | Wire colours | Definition | Connection terminal power supply | Definition |
|  | 2 | Green | D+ | X9 | D+ |
| | 10 | White | D- | X10 | D- |
| | | | | X11 | PE |
| | 4 | Black | GND | X12 | GND |
| | 7 | Brown | +UB | X13 | +UB |
| | | | | | |

| | |
|---|--|
|  | <p>Intrinsically safe connection box of the USB iSCANPS power supply after removal of the wires of the plug connection</p> |
|---|--|



To fully operate the Bluetooth handheld scanner you will require the programming information contained in the manual published by SICK AG (www.SICK.com).

