

IDM Coded / Bluetooth
Hand-held Scanners



General Remarks

Further information on the IDM corded Hand-held scanners can be found on the internet on the IDM product page at www.mysick.com

- Detailed technical data in the online data sheet
- Overview of accessories
- Configuration software IDM Set Up Tool
- EC Declaration of Conformity
- Identification solutions product catalog
- Product information Hand-held scanners

Print out this manual

If you want to print out this manual please ensure that the original size is remained and the print out is of good quality. Otherwise the configuration codes contained in this manual may be distorted and cannot be scanned anymore.

Regulatory

 EN61000-3-2/ EN61000-3-3¹,
EN60950-1, EN61000-6-3,
EN61000-6-2²

 Part 15B, Part 15C⁴

 CNS13438, CNS14336

 AS/NZS CISPR 22:2009 Class B

 LP0002

 KN22, KN24 (KN61000-2,-3,-4,-5,-6,-8,-11)³
Clause 2, Article 58-2 of Radio Waves Act⁴

 V-3/2011.04, TECHNICAL REQUIREMENTS,
Class B ITE³

 2.4 FH 1
技術基準認証済みの無線装置を内蔵  MIC T401

LED Eye Safety IEC62471 Exempt group

Laser Eye Safety IEC60825-1 Class 1

Copyright

Copyright © 2014

SICK AG Waldkirch

Identification & Measuring, Reute Plant

Nimburger Strasse 11

79276 Reute

Germany

Trademark

Adobe™ Reader™ is a trademark of Adobe Systems Incorporated.

¹ Relevant for IDM Corded Hand-held scanners with power supply.

² At the presence of high frequency interference in the frequency range of 15 MHz to 50 MHz there may be performance restrictions.

³ Relevant for IDM Corded Hand-held scanners

⁴ Relevant for IDM Bluetooth Hand-held scanners

Table of contents

1	Getting familiar with your IDM Hand-held scanner	6
1.1	Connectivity	8
1.1.1	Standard Interfaces (RS-232, USB, PS/2)	8
1.1.2	Industrial fieldbus	9
1.2	Technical Specifications	10
1.2.1	IDM Corded Hand-held Scanners	10
1.2.2	IDM Bluetooth Hand-held Scanners	11
2	IDM Bluetooth Scanners	12
2.1	Preparation before using	12
2.1.1	Battery installation	12
2.1.2	Charging the battery	12
2.1.3	Placing the scanner into the cradle	13
2.1.4	USB Bus power	13
2.1.5	Indications	14
2.2	Paging Function	15
2.3	Radio Link Mode	15
2.3.1	PAIR Mode	16
2.3.2	PICO Mode	16
2.3.3	HID Mode	18
2.3.4	SSP Master/ Slave Mode	20
2.4	Out-of-Range Scanning	21
2.5	Presentation Scanning	22
2.6	Sleep Mode & Power Off	22
2.7	Batch Scanning (Inventory Mode)	22
2.7.1	Quantity feature	23
2.7.2	Data output format	23
2.7.3	Transmit stored data	24
2.7.4	Delete data	24
3	Configuration via Barcodes	25
3.1	Programming Commands	25
3.1.1	System Command	25
3.1.2	Family Code	25
3.1.3	Option Code	25
3.2	Programming Procedures	25
3.2.1	Program & End	26
3.2.2	System List & Master Default	27
3.2.3	Single Scan	27
3.2.4	Multiple Scan	28
3.2.5	Cycling Scan	29
3.2.6	Dual Level Scan	30
3.3	Host Interface Selection	31
3.4	Keyboard Interface Control	32
3.4.1	Keyboard Layout (Language)	32
3.4.2	Suffix, Preamble, Postamble, FNC1 Transmit, Caps Lock	33
3.4.3	Delay Settings	34
3.4.4	Function Key & Key Pad Emulation, Upper/Lower Case	35

3.5	Serial Interface Control.....	36
3.5.1	Suffix, Preamble, Postamble	36
3.5.2	Delay Settings	37
3.5.3	Handshaking Protocol, ACK/ NAK	38
3.5.4	Response Time-out, Baud Rate	39
3.5.5	Data Frame.....	40
3.6	Wand/ Laser Emulation Control (IDM1xx series).....	41
3.6.1	Output Polarity, Signal State, Margin/ Module Time	41
3.7	Symbology Reading Control.....	42
3.7.1	User Defined Symbol ID.....	42
3.7.2	Symbology ID Transmission	43
3.7.3	Readable Bar Codes	44
3.7.4	Code 39/ Code 32	46
3.7.5	Code 39	47
3.7.6	Codabar/ NW-7	48
3.7.7	UPC-A/ UPC-E	49
3.7.8	EAN Code.....	52
3.7.9	UCC Coupon Extended Code	54
3.7.10	IATA & Interleaved 2 of 5	55
3.7.11	Code 25 Family	56
3.7.12	Code 11 & Code 93.....	57
3.7.13	MSI/ Plessey	58
3.7.14	Code 128	59
3.7.15	GS1-128.....	60
3.7.16	UK/ Plessey.....	62
3.7.17	Telepen.....	63
3.7.18	GS1 DataBar	64
3.7.19	Composite Codes, Codablock F, PDF417, Micro PDF417	65
3.7.20	Code 16K & Code 49	66
3.7.21	QR Code	67
3.7.22	Data Matrix.....	68
3.7.23	Aztec Code	69
3.7.24	Australian Post, US Planet, US Postnet, British Post, Japan Post	70
3.7.25	Netherland KIX Code, Intelligent Mail & Korea Post Code.....	71
3.7.26	DPM Code	72
3.8	Operation Mode	73
3.8.1	Corded scanners (IDMxx0 series).....	73
3.8.2	Bluetooth scanners (IDMxx1 series).....	74
3.9	Operation Control.....	75
3.9.1	Buzzer, Power On LED, Good read indicator, Vibrator Control.....	75
3.9.2	Dollar Sign, Redundancy, 1D Code Inverse Reading.....	76
3.9.3	Reread Delay, Good Read Delay Control	77
3.9.4	Light Source On Time, Hands Free Time-out.....	78
3.9.5	Presentation Auto-Sense, Sensitivity	79
3.9.6	Presentation Control, Scan Rate, Flash Duty	80
3.9.7	Illumination Control, Presentation Background Lighting.....	81
3.9.8	Aiming, Delay Aiming Time-out, Decode Aiming	82
3.9.9	Center Alignment, Unique Barcode Reporting	83
3.9.10	1D Barcode Reading Direction	84

IDM corded & IDM Bluetooth

3.10	Bluetooth Operation Control (IDM Bluetooth series).....	85
3.10.1	Out-of-range Scanning, Link Supervision Time-Out, Beeping Control	85
3.10.2	Sleep Time-out, Power Off Time-out	86
3.10.3	Bluetooth Batch Scanning	87
3.10.4	Bluetooth Device name, Security Settings.....	89
3.10.5	HID Link Quality, Power Saving Mode	90
3.11	Batch Reading (IDM2xx series).....	91
3.12	Condensed Data Wizard	94
3.12.1	Preamble, Postamble, Data Length, Symbol ID Transmission	94
3.12.2	Data Formatter	95
3.12.3	Data Verifier	96
3.12.4	Data Replacer	97
3.12.5	Data Organizer	98
3.12.6	Select Barcode Symbology.....	99
3.12.7	Position Calculation.....	100
3.12.8	Application Example	100
4	IDM Set Up Tool	102
4.1	Configuration via IDM Set Up Tool	102
4.1.1	IDM Corded Scanners.....	102
4.1.2	IDM Bluetooth Scanners	102
4.2	Firmware Upgrade via IDM Set Up Tool.....	103
4.2.1	IDM Corded Scanner.....	103
4.2.2	IDM Bluetooth Scanner	103
4.2.3	IDM Bluetooth Cradle	104
5	Appendix	105
5.1	Symbology ID Table (1D Codes).....	105
5.2	Symbology ID table (2D and Post codes)	106
5.3	Keyboard Function Code Table	106
5.4	ASCII Input Shortcut (Reference Table).....	107
5.5	GS1-128 ASCII Table	108
5.6	Application Identifier Table.....	111
5.7	Host Interface Quick Set.....	114
5.8	Operation Mode Quick Set	115
5.8.1	1D Corded Scanners (IDM1x0 series)	115
5.8.2	2D Corded Scanners (IDM2x0 series)	116
5.8.3	Bluetooth Scanners	116
5.9	Link Mode Quick Set.....	117
5.10	System Commands	118
5.11	Option Codes.....	120

1 Getting familiar with your IDM Hand-held scanner

The IDM family includes 1D scanners with linear imagers and 2D scanners with area imagers. There are Bluetooth and corded versions available. Furthermore there are different models for variant target applications. IDMX2x and IDMX4x can be used for general purpose applications whereas IDMX6x is designed for industrial environments.

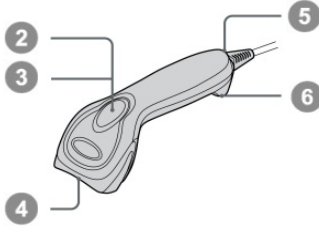
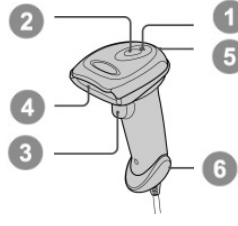
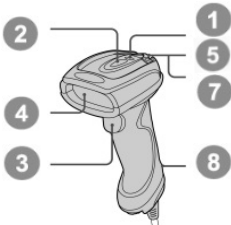
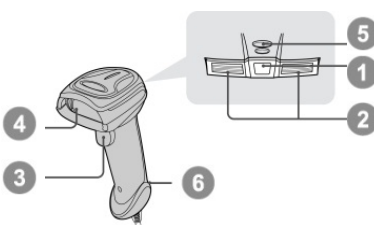
IDM Corded Scanners		
IDM120 Series 	IDM140 Series 	<ul style="list-style-type: none"> 1 Power Indicator 2 Status Indicator 3 Trigger 4 Scan Window 5 Beeper 6 Cable Release Hole 7 Tether Plate 8 Lanyard Catch
IDM160/260 Series 	IDM240 Series 	

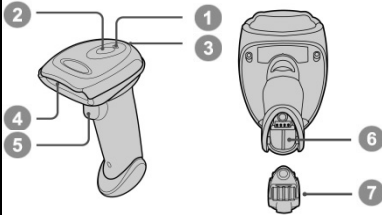
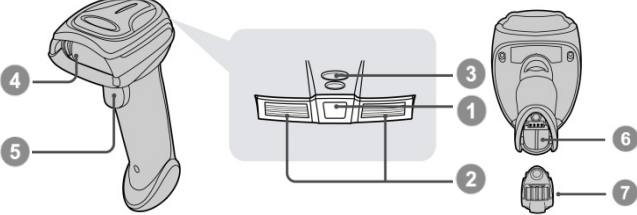
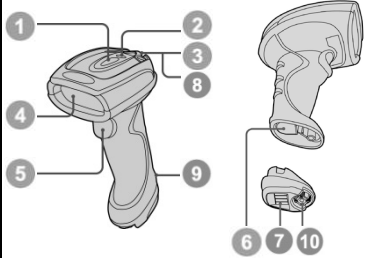
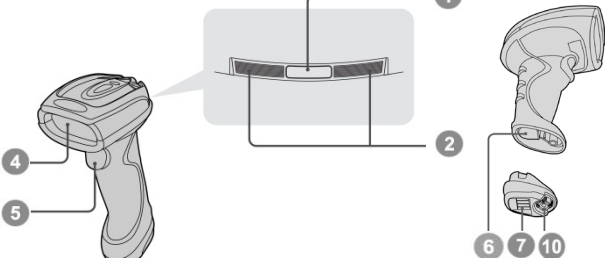
IDM Bluetooth Scanners		
IDM140 BT Series 	IDM241 Series 	<ul style="list-style-type: none"> 1 Link Indicator 2 Status Indicator 3 Beeper 4 Scan Window 5 Trigger 6 Battery Cavity 7 End Cap 8 Tether Plate 9 Lanyard catch 10 Retaining Screw
IDM160 BT Series 	IDM261 Series 	

IDM corded & IDM Bluetooth

IDM Bluetooth Cradles		
<p>IDM140 BT/ IDM241 Smart Cradle</p>	<p>IDMx4x Charging Cradle</p>	<ul style="list-style-type: none"> 1 Power Indicator 2 Status Indicators 3 Paging/ reset button 4 USB Bus Power Switch 5 Host interface port 6 DC Power Jack 7 Reserved
<p>IDM160 BT/ IDM261 Smart Cradle</p>	<p>IDMx6x Charging Cradle</p>	

1.1 Connectivity

To connect the scanner, plug the cable into the interface port of the scanner and connect it to the host. To remove the cable, straighten one end of a paper clip and insert it into the cable release hole to pull out the cable. For IDM160/260 series you need to push down the bracket of the enclosure clip and pull out the cable.

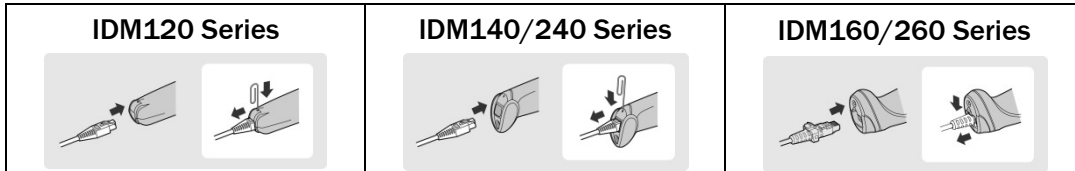

For IDM Bluetooth scanners the cable needs to be connected to the smart cradles. The cable inlet is on the bottom side of the cradles.

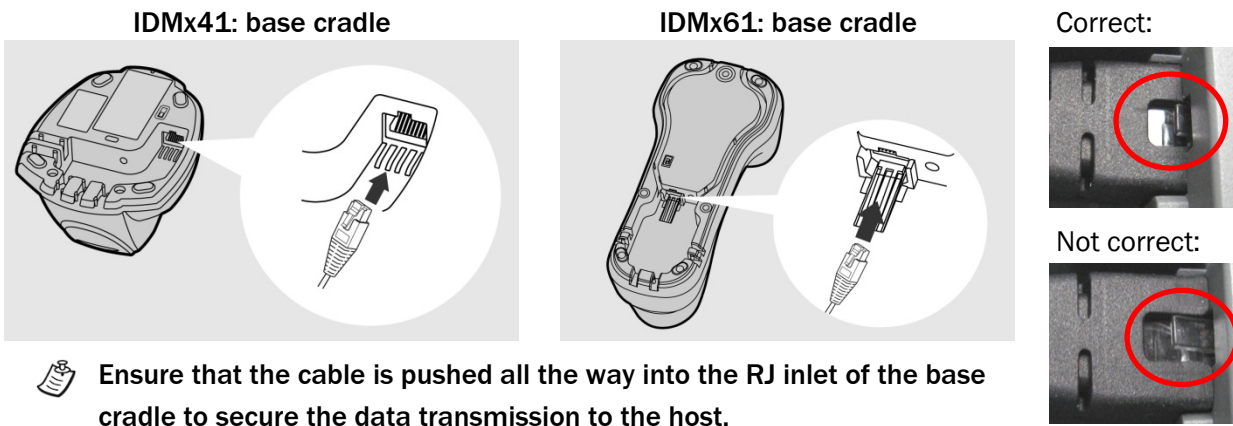

1.1.1 Standard Interfaces (RS-232, USB, PS/2)

IDM scanners support USB¹, PS/2(DOS/V) Keyboard Wedge and RS-232 Serial interfaces.

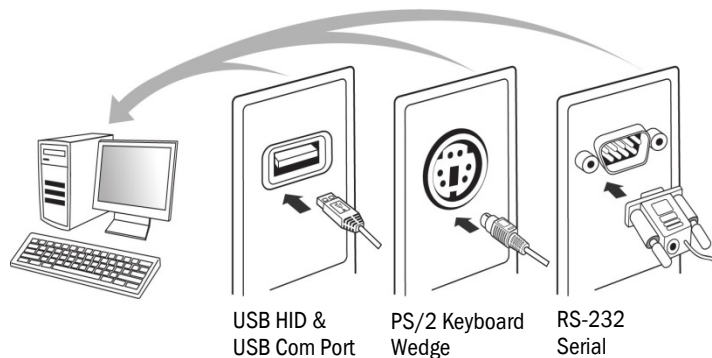



- **USB HID (Human Interface Device):** The scanner works as a generic USB Keyboard.
- **USB COM:** The scanner works as a RS-232 serial device. Please note that you have to install the USB COM Port driver (available on www.mysick.com) before use.

¹ USB is not suitable for use in industrial environments. Therefore, at cable installation it is important to ensure that there are no close sources of interference.

IDM corded & IDM Bluetooth

Depending on the Scanner model different cables are available.

				IDM120, IDMx40, IDM Bluetooth	IDM160, IDM260
USB 	straight	1.8 m	6036728	6045195	
	spiral	3.8 m ¹	6039158	6045232	
RS-232 	straight	1.8 m	6041540	6045196	
	spiral	3.8 m	6039156	6045233	
PS/2 	straight	2.0 m	6036726	6045194	
	spiral	3.8 m	6039155	6045231	
Power Supply	needed for operation with RS-232 cables ² , Bluetooth and Wifi			6036722	

1.1.2 Industrial fieldbus

The IDM Hand-held scanners can be connected to industrial fieldbuses (such as PROFIBUS, PROFINET, Ethernet TCP/IP, DeviceNet, etc.) via SICK connection modules and an adapter cable. The adapter cable includes a voltage converter from DC 24 to 5 V for the voltage supply of the hand-held scanner, eliminating the need of a separate power supply.

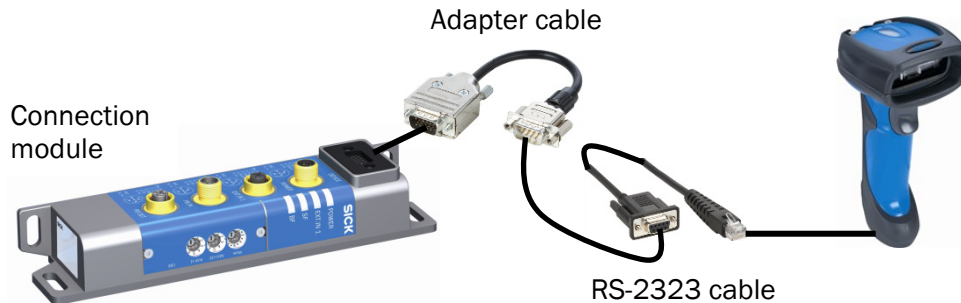

 For more information on necessary components and order numbers please contact your local SICK sales representative.

¹ If you want to use this cable for USB Com Port Mode, it is recommended to use an additional USB hub between cable and PC. The USB hub will boost the communication signal and secure the communication.

² If there is no power on Pin 9.

1.2 Technical Specifications

1.2.1 IDM Corded Hand-held Scanners

Type	IDM120	IDM140	IDM160	IDM240	IDM260
Field of application	General Purpose	General Purpose	Industrial	General Purpose	Industrial
Enclosure rating	IP 41	IP 41	IP 65	IP 41	IP 65
Supported code types	1D, Stacked ¹			1D, Stacked, 2D	1D, Stacked, 2D, DPM ²
Code resolution	≥0.102 mm ¹⁾	≥0.076 mm ¹⁾		SR model: ≥0.08 mm ¹⁾ , ≥0.18 mm ²⁾ HD model: ≥0.08 mm ¹⁾ , ≥0.13 mm ²⁾	
Reading distance (at code resolution)	0 mm ... 250 mm (0.33 mm) ¹⁾	50 mm ... 600 mm (0.5 mm) ¹⁾	50 mm ... 800 mm (0.5 mm) ¹⁾	SR model: 30 mm ... 155 mm (0.25 mm) ²⁾ HD model: 35 mm ... 90 mm (0.13 mm) ²⁾	
Interfaces	USB (Keyboard Wedge & Com Port Emulation), RS-232 TTL, PS/2 (Ethernet TCP/IP, PROFINET, PROFIBUS, DeviceNet) ³				
Optical indicators	1 LED (good read)	2 LEDs (operational status, good read)			
Vibration	No	No	Yes	No	Yes
Acoustic indicators	Beeper, disengageable				
Operating Voltage	5 V DC (+/- 5%)				
Current consumption (Operating)	Typical 170 mA	Typical 180 mA	180 mA (Vibrator disabled) 230 mA (Vibrator enable)	Typical 285 mA	Max. 285 mA (Vibrator disabled) Max. 335 mA (Vibrator enable)
Current consumption (Standby)	Typical 75 mA	Typical 80 mA	Typical 90 mA	Typical 160 mA	Max. 150 mA
Light source	LED: visible red light (630 nm)				
Laser aimer	No				Yes (Laser Class 1)
Ambient operating temperature	0 °C ... 50 °C		-20 °C ... 50 °C	-10 °C ... 50 °C	-20 °C ... 50 °C
Storage temperature	-20 °C ... 60 °C	-40 °C ... 70 °C	-30 °C ... 70 °C	-40 °C ... 70 °C	-40 °C ... 70 °C

¹⁾ Valid for Code 39, ²⁾ Valid for Data Matrix

¹ Depending on scanner version (PDF version is necessary).

² Depending on scanner version (DPM version is necessary).

³ Optional via external SICK connection modules.

IDM corded & IDM Bluetooth

1.2.2 IDM Bluetooth Hand-held Scanners

Type	IDM140 BT	IDM160 BT	IDM241 BT	IDM261 BT
Field of application	General Purpose	Industrial	General Purpose	Industrial
Enclosure rating	IP 41	IP 65	IP 41	IP 65
Supported code types	1D, Stacked ¹	1D, Stacked ¹	1D, Stacked, 2D	1D, Stacked, 2D, DPM ²
Code resolution	≥0.076 mm ¹	≥0.076 mm ¹	SR model: ≥0.08 mm ¹ , ≥0.18 mm ² HD model: ≥0.08 mm ¹ , ≥0.13 mm ²	
Reading distance (at code resolution)	50 mm ... 600 mm (0.5 mm) ¹	50 mm ... 800 mm (0.5 mm) ¹	SR model: 30 mm ... 155 mm (0.25 mm) ² HD model: 35 mm ... 90 mm (0.13 mm) ²	
Interfaces	USB (Keyboard Wedge & Com Port Emulation), RS-232 TTL, PS/2 (Ethernet TCP/IP, PROFINET, PROFIBUS, DeviceNet) ³			
Bluetooth Protocol	Bluetooth v 2.1 EDR, 2.4 ... 2.4835 GHz		Bluetooth v 4.0, 2.402 ... 2.4830 GHz	
Bluetooth operating range	Up to 100 m (free view), Batch function for expansion of the wireless radius		Up to 100 m (free view), Batch function for expansion of the wireless radius	
Optical indicators	2 LEDs (good read, charge of battery, radio connection status)			
Vibration	No	Yes	No	Yes
Acoustic indicators	Beeper, disengageable			
Operating Voltage	5 V DC (+/- 5%)			
Current consumption (Operating)	180 mA	230 mA (Vibrator enabled) 180 mA (Vibrator disabled)	300 mA	330 mA (Vibrator enabled) 300 mA (Vibrator disabled)
Current consumption (Standby)	80 mA	90 mA	180 mA	180 mA
Light source	LED: visible red light (630 nm)			
Laser aimer	No	Yes (Laser Class 1)	No	Yes (Laser Class 1)
Ambient operating temperature	0 °C ... 50 °C	-20 °C ... 50 °C	-10 °C ... 50 °C	-10 °C ... 50 °C
Storage temperature	-40 °C ... 70 °C	-30 °C ... 70 °C	-40 °C ... 70 °C	-40 °C ... 70 °C

¹) Valid for Code 39, ²) Valid for Data Matrix

For detailed technical specifications, see the *Online Data Sheet* on the product site on the web (www.mysick.com/en).

¹ Depending on scanner version (PDF version is necessary).

² Depending on scanner version (DPM version is necessary).

³ Optional via external SICK connection modules.

2 IDM Bluetooth Scanners

2.1 Preparation before using

2.1.1 Battery installation

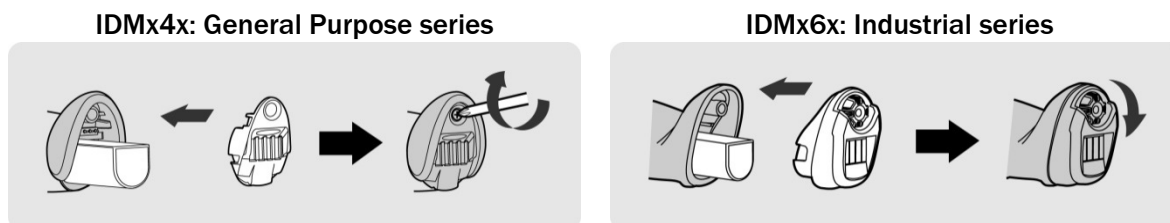

1. Ensure the battery contacts of the battery pack are facing the charging contacts inside the battery cavity. 
2. Slide the battery pack into the battery cavity until hearing a click sound before locking it with the end cap. The scanner will give 4 beeps when the battery pack is installed properly if the battery pack still has power.
3. Secure the end cap with the screw provided.

 You can use the overlapping battery label to pull out the battery if needed.

2.1.2 Charging the battery

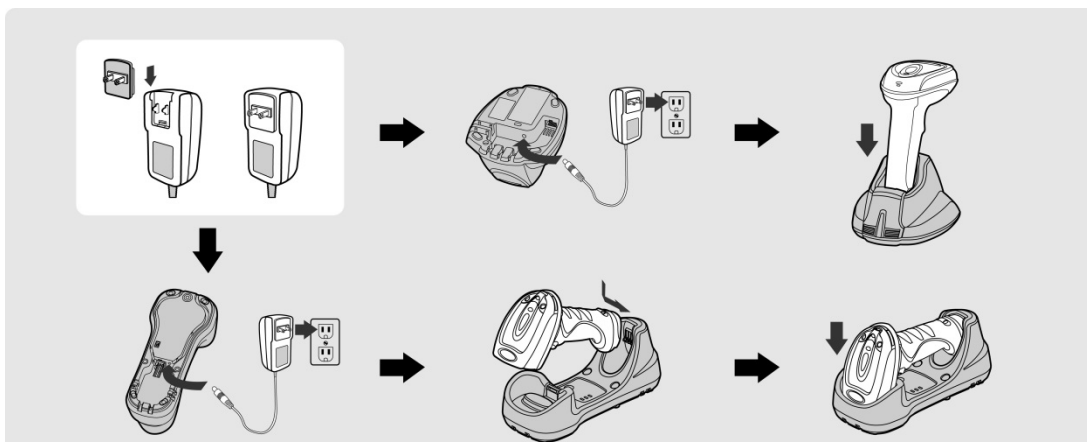

1. Choose an appropriate plug for your country and slide it into the power adapter cavity until it is locked. Then plug the AC power plug into the AC wall socket.
2. Plug the DC power cord of the power supply unit into the DC Jack of the cradle. The smart cradle emits the power-on beeps and the central (IDMx4x)/ upper (IDMx6x) power indicator gives one blue blink. If you use the charging cradle, the central (IDMx4x)/ upper (IDMx6x) power indicator turns steady blue.
3. Place the scanner on the cradle. The status indicator of scanner will turn steady red if the battery is not fully charged. When the battery is fully charged, the status indicator of the scanner turns steady green.

 Please note the important battery information on the next page!

IDM corded & IDM Bluetooth



Important information: Please charge the new battery pack for **8 hours** prior to the first use. Ensure that you are using a battery with enough capacity. Otherwise the scanner might lose its radio connection. As soon as the scanner gives warning messages (one red blink and one beep at a regular interval) the scanner needs to be recharged. If the scanner gives 8 red blinks and 8 beeps, the battery power is extremely low. In that case the battery needs to be recharged immediately! If the scanner is not placed into the charging cradle right the way, the scanner turns off automatically. Due to an internal protection circuit there will now be measured 0 V on the outside contacts of the battery. If the battery is not recharged immediately, a further discharge takes place even though the scanner is turned off. Due to the internal chemical processes of lithium ion batteries, this will then result in an irreversible destruction of the battery.

2.1.3 Placing the scanner into the cradle

Ensure that the scanner is placed properly into the respective smart or charging cradle. If the unit is not placed correctly into the cradle, the charging might not start.

IDMx41: Insert the scanner vertically

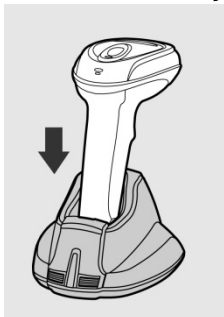

IDMx61: Insert the back of the scanner first. Afterwards push the scanner head down.

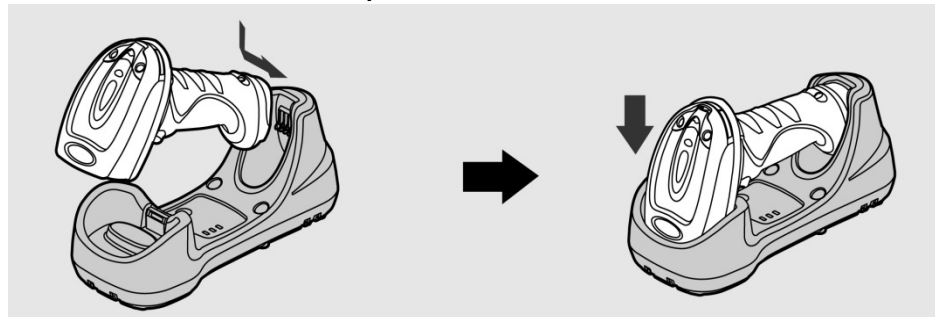

The correct placement into the cradle can be verified by the charging LED on the scanner. (See also chapter 2.1.5 on page 14)

2.1.4 USB Bus power

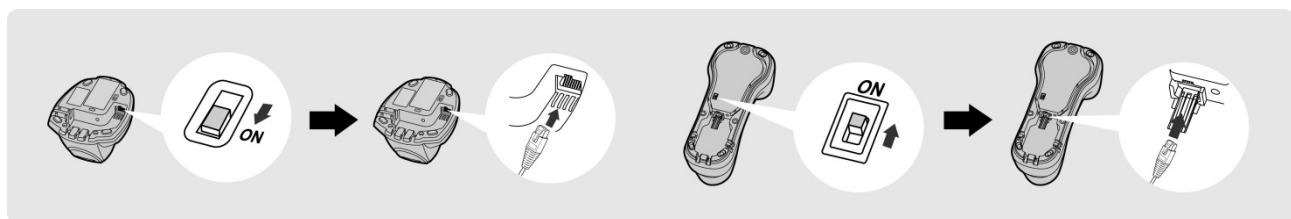

- If USB 3.0 is available in your host device, both battery charging and regular operation can be supported by the USB Bus Power without using external power supply.
- If you want to use this feature, set the USB bus power switch to “ON”. Then connect the cradle and host device via an USB cable.
- If only USB 2.0 is available in your host device the external power supply is necessary as a power source, because the power supplied from USB 2.0 is not enough to support both battery charging and regular operation simultaneously.

2.1.5 Indications

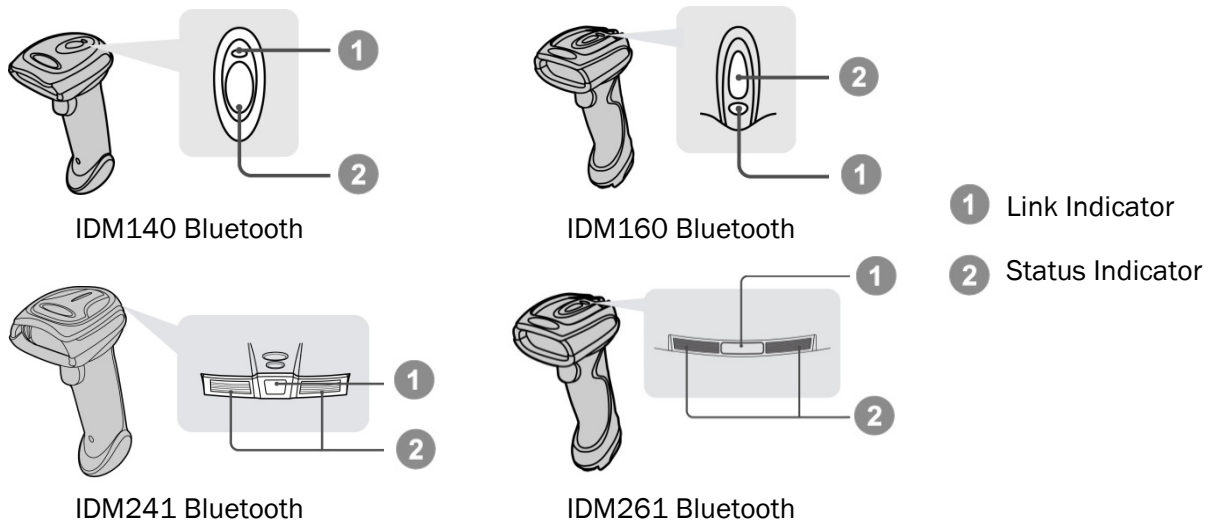

IDM Bluetooth Scanners

Description	Link indicator	Beeper
Radio connection	1 blue blink per 2.5 sec.	Off
Radio disconnection	3 blue blinks per 2 sec.	Off
During connection	Quick blue blinks	Short clicks
Radio connection built	1 blue blink per 2.5 sec.	4 beeps in ascending tone
Radio connection lost	3 blue blinks per 2 sec.	4 beeps in descending tone
Data Transmission	Quick blue blink	Short clicks
Description	Status Indicator	Beeper
Under charging (on cradle)	Steady red	Off
Fully charged (on cradle)	Steady green	Off
Under batch scanning	1 green blink per 2.5 sec.	Off
Pair failure	Steady red	2 Di-do Di-do beeps
Out of memory	2 red blinks	2 long beeps
Battery power low	1 red blink at regular interval	1 beep at regular interval
Battery power extremely low	8 red blinks	8 beeps
Good read	1 green blink	1 good read beep
Under Configuration	Steady red	Off
Uninstall state	Alternative red and green blinks	Off
Upgrade state	Steady red	Short click
Time out warning	Off	3 long beeps
Paged by smart cradle	Off	6 page beeps
Sleep state / Battery no power	Off	Off
Power Off	Off	Off

IDM corded & IDM Bluetooth

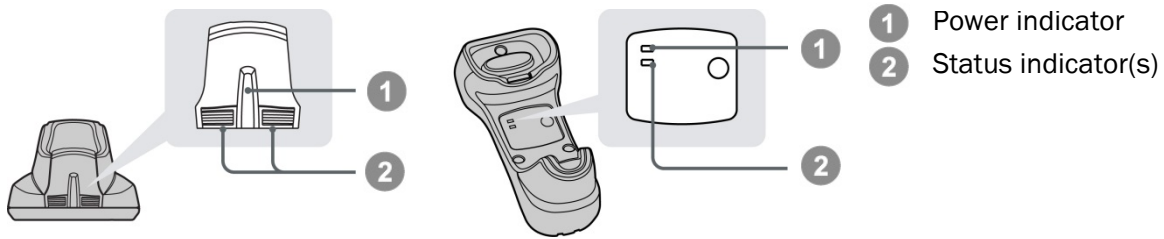

IDM Smart Cradle

Description	Indicators		Beeper	
	Power	Status		
Power on	1 blue blink	Off	Power on beeps	
Smart Cradle Upgrade State	Off	Steady red	Short clicks	
Uninstall state	Off	Alternative red-green blinks	Off	
PICO Mode	Radio Connected	Steady blue	Steady Green	Off
	Radio Disconnected	Off	Steady red	Off
PAIR Mode	Radio Connected	Steady blue	Off	Off
	Radio Disconnected	Off	Steady red	Off
Smart cradle paged by scanner	PICO Mode	Steady blue	Steady green	6 page beeps
	PAIR Mode	Steady blue	Off	6 page beeps

IDM Charging Cradle

Description	Power Indicator	Beeper
Power on	Steady blue	Off

2.2 Paging Function

The paging function helps to locate the paired smart cradle or scanner. If you would like to page the paired smart cradle, you can scan the “Paging” command.



Paging

If you would like to page the paired scanner, you can press the paging/rest button of the smart cradle no longer than 5 seconds.

2.3 Radio Link Mode

The IDM Bluetooth scanners provide several radio link modes to communicate with the host device. When the Bluetooth-enabled host device is not available, the scanner can work with the smart cradle in PAIR mode (peer-to-peer connection) or PICO mode (multiple connections) to provide a plug-and-play cordless migration of your existing non-Bluetooth devices. Moreover, you are able to use the scanner to work with Bluetooth-enabled host devices via SPP mode or HID mode. When the radio link is disconnected, the scanner is capable of reconnecting the radio link automatically when it returns into the Bluetooth radio range area. Please note

that this feature is not available in SPP slave mode. If you would like to change the radio link mode, please scan the “Uninstall” command to reset the scanner to the uninstall state.

2.3.1 PAIR Mode

In PAIR mode, one smart cradle will work with one scanner. The smart cradle does not only provide the Bluetooth radio link with the scanner, but also offers the legacy cabled interfaces to the host device, including USB HID, USB COM, PS/2(DOS/V) Keyboard Wedge and RS-232 serial.

Use IDM Hand-held scanner in PAIR Mode:

1. Ensure the battery is fully charged. Refer to the section of “2.1.2 Charging the battery” for details.
2. Choose the interface cable, plug it into the smart cradle and connect it to the host device. (Refer to chapter “1.1 Connectivity” for details.)
3. Turn on the power of your host device.
4. Note that if the scanner is shipped together with a smart cradle, they are pre-paired already. You will see the link indicator of the scanner shows 1 blue blink per 2.5 seconds and the central (IDMx41)/ upper (IDMx61) power indicator of the smart cradle turns steady blue. If the scanner and smart cradle just give alternative red and green blinks (“Uninstall” state), please follow step 5 to establish the connection between scanner and smart cradle.
5. Scan the “PAIR mode” command. The status indicator of the scanner will turn steady red immediately.



Uninstall



PAIR Mode

Place the scanner into the smart cradle. You will hear one short beep to indicate the activation of the pairing process. The scanner will emit continuous short clicks and the link indicator of the scanner will flash blue quickly during the pairing process. When you hear 4 beeps in ascending tone, the pairing process is completed. You will see that the link indicator of the scanner gives 1 blue blink per 2.5 seconds and the central (IDMx41)/ upper (IDMx61) power indicator of the smart cradle turns steady blue. If the scanner pairing process failed or if the scanner is not placed into the smart cradle within 20 seconds, you will hear 2 “Di-do Di-do” beeps indicating that the pairing process was not successful. The scanner will return to the uninstall state automatically.

6. Scan the corresponding host interface quick set command (chapter 5.7) to complete the installation.

 The default host interface of the smart cradle is preset to USB HID. If you want to set the host interface to USB COM you need to install the USB COM Port driver (available on www.mysick.com) before using.

2.3.2 PICO Mode

In PICO mode up to 7 scanners can be connected to one smart cradle. If you would like to un-pair all scanners paired with the smart cradle, please press and hold the paging/reset button of the smart cradle for more than 5 seconds. If you just want to un-pair part of the paired scanners, please take those paired scanners and scan the “Uninstall” command.

Use IDM Hand-held scanner in PICO Mode:

1. Ensure the battery is fully charged. You may refer to the section of “2.1.2 Charging the battery” for details.
2. Choose the interface cable, plug it into the smart cradle and connect it to the host device. (Refer to chapter “1.1 Connectivity” for details.)
3. Turn on the power of your host device.
4. Ensure the side (IDMx41)/ lower (IDMx61) status indicators of the smart cradle shows alternative red and green blinks (“Uninstall” state). If the smart cradle is paired with other scanners press and hold the paging/ rest button for more than 5 seconds to un-pair all paired scanners. This way the smart cradle will return to uninstall state automatically.
5. Prepare the scanners you would like to pair with the smart cradle. Ensure that the status indicator of each scanner gives alternative red and green blinks (“Uninstall state”). If the scanner is no in the “Uninstall state”, scan the “Uninstall” command to un-pair the scanner, then scan the “PICO Mode” command. The status indicator of the scanner will turn to steady red.



Uninstall



PICO Mode

Place the scanner into the smart cradle. You will hear one short beep to indicate the activation of the pairing process. The scanner will emit continuous short clicks and the link indicator of the scanner will flash blue quickly during the pairing process. When you hear 4 beeps in ascending tone, the pairing process is completed. You will see that the link indicator of the scanner shows 1 blue blink per 2.5 seconds. The central (IDMx41)/ upper (IDMx61) power indicator of the smart cradle turns steady blue and the side (IDMx41)/ lower (IDMx61) status indicators turn steady green.

If the scanner pairing process failed or if the scanner is not placed into the smart cradle within 20 seconds, you will hear 2 “Di-do Di-do” beeps to warn the failure of pairing. The scanner will return to the uninstall state automatically.

6. Scan the corresponding host interface quick set command to complete the installation.
7. Repeat the same procedure to pair other scanners (up to seven scanners in total) with the smart cradle.



For the user’s convenience, the smart cradle will automatically assign an ID number to each scanner. Scan the “System Information” command to check the assigned ID number of each scanner.

Clone Function

For the user’s convenience, the clone function will help you to clone the host interface related parameters (please refer to the following table for details) from one of the paired scanners to the rest of the paired scanners under PICO mode. You can use one of the paired scanners to set the host interface related parameters first and then scan the “Save Configuration” command. Afterwards, please take the other paired scanners to scan the “Clone” command one by one to clone the host interface related parameters.

For using the Clone function, the paired scanners need to stay connected. The host interface related parameters can't be cloned to the paired scanner in disconnected status.



Save Configuration



Clone

The below host interface related parameters will be impacted by the cloning function:

Data Transmission Parameter	Field Delimiter
	Data Transmission Format
Host Interface Control	Host interface Selection
Keyboard Interface Control	Keyboard Layout
	Intermessage Delay
	Interfunction Delay
	Intercharacter Delay
	Caps Lock Control
	Caps Lock Release Control
	Function Key Emulation
	Key Pad Emulation
	Upper/Lower Case
Serial Interface Control	Handshaking Protocol
	Intermessage Delay
	Interfunction Delay
	Intercharacter Delay
	Baud Rate
	Data Frame
	Time Out Control
Wand Emulation Control	Output Polarity
	Initial Signal State
	Margin Time
	Module Time
	Narrow/Wide Ratio
	Code39 Emulation

2.3.3 HID Mode

Through the HID service, the scanner can work as a Bluetooth Keyboard. In this mode, the scanner will be discoverable by the radio connection request issued by the remote host device. In some cases, you may be requested to enter the Passkey (PIN) to establish the Bluetooth connection for security purpose.

Use IDM Hand-held scanner in HID Mode:

1. Ensure the battery is fully charged. You may refer to the section of “2.1.2 Charging the battery” for details.
2. Power on the scanner within radio range.
3. Ensure the status indicator of the scanner gives alternative red and green blinks (“Uninstall” state). If the scanner is not in uninstall state scan the “Uninstall” command first.

**Uninstall**

4. If your remote host is equipped with the latest Bluetooth drivers or if it is an iOS or Android device we recommend to use “HID Mode” for quick pairing. If necessary you may use “HID Mode with Passkey” to establish a more secure connection. If you experience problems in “HID Mode” try “HID Legacy Mode” instead.

**HID Mode****HID Legacy Mode****HID Mode with Passkey**

5. Once you scan one of the above commands the link indicator of the scanner will give 3 blue blinks per 2 seconds during the searching process. You have to execute the Bluetooth Discovery procedure to find available Bluetooth devices. Select “IDMxxx”.
6. If you use “HID Mode” go to step 9.
7. If you use “HID Mode with Passkey” you will be requested to enter the passkey (PIN) on the remote host. Please enter the passkey (PIN) accordingly by scanning the “Option Codes” on page 120 and then scan “FIN (Finish)” to end the passkey entry. Continue with step 9.
8. If you scan “HID Legacy Mode” the passkey (PIN) may be requested. Please enter “00000000” (default setting). You will see “Keyboard on IDMxxx”. Double-click this HID service to establish the connection between the scanner and the remote host device.
9. The scanner will emit 4 beeps in ascending tone to indicate the radio is connected. At the same time, the link indicator of the scanner will give 1 blue blink per 2.5 seconds to indicate the scanner is in radio-connected state. Please note that if the scanner failed to connect to the host device within 30 seconds, the link indicator will give 3 blue blinks per 2 seconds. But the scanner is still continuing to discover the host device for another 30 seconds before going to sleep mode. In the interim, you still can scan “Uninstall” command to revert the scanner to uninstall state. If the scanner goes to sleep mode, you need to press the trigger to wake up the scanner to continue the installation.



The above procedures are based on popular Windows environment. However, the installation procedure may vary depending on different remote host devices, operating systems and the Bluetooth drivers.

 While using HID mode be aware of potential error in the data transmission when radio link quality is poor. You are suggested to use the scanner under the communication coverage at all times.

2.3.4 SSP Master/ Slave Mode

Through the standard SPP service, the scanner can work as a Bluetooth Serial Device. In SPP Master Mode, the scanner initiates the radio connection request to the remote slave device. In SPP slave mode, the scanner will be discoverable by the radio connection request issued by the remote host device.

Establish SSP Master Connection

1. Ensure the battery is fully charged. Open the folder “Hardware” located in Bluetooth Advanced Setting of the remote host device to check its device MAC address. Then prepare a 12-character Code 128 barcode of the remote host device MAC address, or follow the step 4 to input MAC address by scanning 12 option codes.
2. Ensure a virtual COM port is available in your remote host for connecting the scanner. If not, please open the folder “Local Services” located in Bluetooth Advanced Setting. Click the “Add Serial Services” to add one more Bluetooth COM port.
3. Power on the scanner within radio coverage and ensure the status indicator of the scanner gives alternative red and green blinks (“Uninstall” state). If the scanner is not in uninstall state, please scan the “Uninstall” command first, and then scan the “SSP Master Mode” command. The status indicator of the scanner will turn steady red immediately.



4. Scan a 12-character MAC address barcode, or scan 12 option codes and “FIN” command to confirm your inputs. The scanner will emit continuous short clicks and the link indicator of the scanner will flash blue quickly during the radio connecting process. If the PIN Code or Passkey is requested, please enter “00000000” (default setting).
5. The scanner will emit 4 beeps in ascending tone to indicate the radio is connected. At the same time, the link indicator of the scanner will give 1 blue blink per 2.5 seconds to indicate the scanner is in radio-connected state. Please note that if the scanner failed to connect to the host device within 30 seconds, the link indicator will give 3 blue blinks per 2 seconds. But the scanner is still continuing to discover the host device for another 30 seconds before go to sleep. In the interim, you still can scan the “Uninstall” command to revert the scanner to uninstall state. If the scanner is already in sleep mode, you just need to press the trigger to wake up the scanner to continue the installation.

 The above procedures are based on popular Windows environment. However, the installation procedure may vary depending on different remote host devices, operating systems and the Bluetooth drivers.

Establish SSP Slave Connection

1. Ensure the battery is fully charged and a virtual COM port is available in your remote host for connecting the scanner. If not, please open the folder “Client Applications” located in Bluetooth Advanced Setting. Click the “Add COM Port” to add one more Bluetooth COM port.
2. Power on the scanner within radio coverage and ensure the status indicator of scanner gives alternative red and green blinks (in “Uninstall” state). If the scanner is not in uninstall state, please scan the “Uninstall” command first. Then scan the “SPP Slave Mode” command, and the link indicator of scanner will give 3 blue blinks per 2 seconds during searching process.



Uninstall



SSP Slave Mode

3. Execute the Bluetooth Discovery procedure to find all available Bluetooth device list in your remote host. You will see “IDMxxx” is shown in the list if the scanner is successfully discovered.
4. Double click the “IDMxxx” on the discovered Bluetooth devices. If the PIN Code or Passkey is requested for security connection, please enter “00000000” (default setting). You will see “Serial Port on IDMxxx”. Please double click this SPP service to establish the connection between scanner and remote host device.
5. The scanner will emit 4 beeps in ascending tone to indicate the radio is connected. At the same time, the link indicator of the scanner will give 1 blue blink per 2.5 seconds to indicate the scanner is in radio-connected state. Please note that if the scanner is not connected to the host device within 1 minute after scanning the “SPP Slave Mode” command, the scanner will go to sleep mode automatically. You can just press the trigger to wake up the scanner to continue the installation.

 The above procedures are based on popular Windows environment. However, the installation procedure may vary depending on different remote host devices, operating systems and the Bluetooth drivers.

2.4 Out-of-Range Scanning

When the radio connection is established between scanner and remote host device, the scanner will transmit each scanned code content right after scanning the barcode. However, the scanner is preset not to scan any barcode data when it loses the radio connection with the remote host device.

If you enable the Out-of-Range scanning function, the scanner can continue scanning barcode data while it is out of radio coverage. All scanned data will be temporarily stored in the memory buffer until radio link resumed.



Enable Out-of-Range Scanning



Disable Out-of-Range Scanning

If the scanner is out of radio coverage, you will hear 4 beeps in descending tone to indicate the loss of radio connection. The link indicator of the scanner will give 3 blue blinks per 2 seconds. Once the scanner is back

to radio coverage, you will hear 4 beeps in ascending tone to indicate the radio connection is rebuilt and the scanner will give 1 blue blink per 2.5 seconds. At the same time, all stored scanned data will be transmitted automatically right after the radio link is resumed.

2.5 Presentation Scanning

The Presentation Scanning is designed for hand-free applications. If the “Presentation Scanning Auto-sense” function is enabled, the scanner is capable of automatically switching to presentation mode as soon as you place the scanner onto the Presentation Stand or into Smart Cradle.

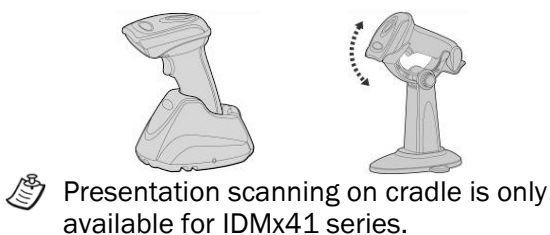

Disable Auto-sense



Enable Auto-sense

2.6 Sleep Mode & Power Off

The scanner is preset to enter “Sleep Mode” if the scanner is not used after time-out duration. When the scanner is under sleep mode, it is preset to enter “Power Off” automatically if it will not be waked up after time-out duration.

If you want your scanner to enter “Sleep Mode” or “Power Off” immediately, please scan the “Sleep Mode” or “Power Off” command. The scanner can be waked up by pressing the trigger button.



Sleep Mode



Power Off

2.7 Batch Scanning (Inventory Mode)

With the help of the Batch Scanning function, the scanner is capable of storing the barcode data of up to 100,000 EAN-13 barcodes. This functionality is often used for inventory applications.

Once you scan the “Enter Batch Scanning” command to activate this function, all scanned barcode data will be stored into the memory storage and the status indicator of scanner will give green blink at regular interval during batch scanning. You can scan and store the barcode data till the memory storage is full. If the storage is full, you will hear 2 long beeps and the status indicator will give 2 red blinks to indicate out of storage. To terminate the batch scanning, please scan the “Exit Batch Scanning” command.



Enter Batch Scanning



Exit Batch Scanning

2.7.1 Quantity feature

The scanner supports quantity feature when it enters batch scanning. When you use quantity feature, the quantity information and scanned barcode data will be stored into the memory storage together. You can enter the quantity information from 1 to 9999 by scanning the following quantity commands right after you scanned the barcode data.



2.7.2 Data output format

There are three ways to output the stored barcode data and quantity information. The preset output format is to transmit stored data as many times as the quantity indicates. But you still can set the scanner to output stored barcode data together with quantity information in two fields, and a preset delimiter (“,”) will be output in between. To fulfill different application requirements, both the delimiter and the output sequence can be changed.



2.7.3 Transmit stored data

The scanner is preset to transmit all the stored data by scanning the “Transmit Stored Data” command. During the transmission, the scanner will emit continuous short clicks and the link indicator will blink blue. Then the scanner will give two short beeps after data transmission is completed.



Transmit stored data

You are still able to set the scanner to transmit the stored data by placing the scanner onto the cradle as well.



Scan Barcode Command ◆



Place scanner onto the cradle



Scan command or place scanner onto the cradle

2.7.4 Delete data

If a wrong barcode was scanned, the “Delete Last Scanned Data” command is helpful to recover mistakes. By scanning the “Delete Last Scanned Data” command, the last stored data can be deleted.



Delete last scanned data

The scanner is preset to keep all the stored data until you scan the “Clear All Stored Data” command. However you are also able to change the setting to “Auto Delete Stored Data after transmission”. (Refer to chapter 3.10.3)



Clear all Stored Data

3 Configuration via Barcodes

3.1 Programming Commands

The IDM scanner bar code commands are specially designed proprietary bar code labels which allow you to set the IDM Scanner's internal programming parameters. There are **System Command**, **Family Code** and **Option Code** for programming purpose.

Each programmable family and bar code command label is listed on the same page with major system commands. The detailed explanations and special programming flowchart are printed on facing or following pages. The Option Codes and System Commands can be found in the appendix on page 116 and 118.

3.1.1 System Command

The System Command is the highest level bar code command which directs the IDM Scanner to perform immediate operations, such as entering programming mode (PROGRAM), exiting programming mode (EXIT), listing system information (SYSLIST), recovering to factory preset configurations (M_DEFAULT) and so on. Please note that all system commands will take a few seconds to complete the operations. User must wait for the completion beeps before scanning another bar code.

3.1.2 Family Code

The Family Code is scanned to select the user desired programming family. IDM Scanner has already provided more than one hundred programming families to meet any specific requirements.

3.1.3 Option Code

The Option Codes is a set of bar code commands represented by "0-9", "A-F" and finishing selection (FIN). For most setting, you must select at least one option code following the family code selection to set the desired parameter for the selected programming family. The Option Codes can be found on page 116.

3.2 Programming Procedures

As you scan the bar code command to select the desired parameters, information about the final selected parameters represented by the bar code commands are stored in the Hand-held scanner's internal Flash Memory ASIC or non-volatile memory. If you turn off the unit, the Flash Memory ASIC or non-volatile memory retains all programming options. You don't need to re-program the IDM Scanner if you want to keep the existing configurations in the next power on.

The programming procedures of the IDM Scanner are designed as simple as possible for ease of setting. Most programming families take the "*Single Scan Selection*" programming procedure. But several programming families have more complex and flexible programmable options, and you must take "*Multiple Scan Selection*", "*Cycling Scan Selection*" or "*Dual Level Selection*" to complete their programming procedures. Each kind of programming procedure is listed in the following pages for your reference. Please give careful attention to become familiar with each programming procedure.

If the programming family must take “Multiple Scan Selection”, “Cycling Scan Selection”, or “Dual Level Selection” procedures, the family of the programming menu will be marked with the matched representing symbol of Programming Category (P.C.) listed in the following table.

Conventions	Descriptions
◆	Factory default value
P.C.	Programming category
	SS: Single scan selection
	MS: Multiple scan selection
	CS: Cycling scan selection
	DS: Dual level scan selection
()	Necessary option code
[]	Selectable option code

3.2.1 Program & End

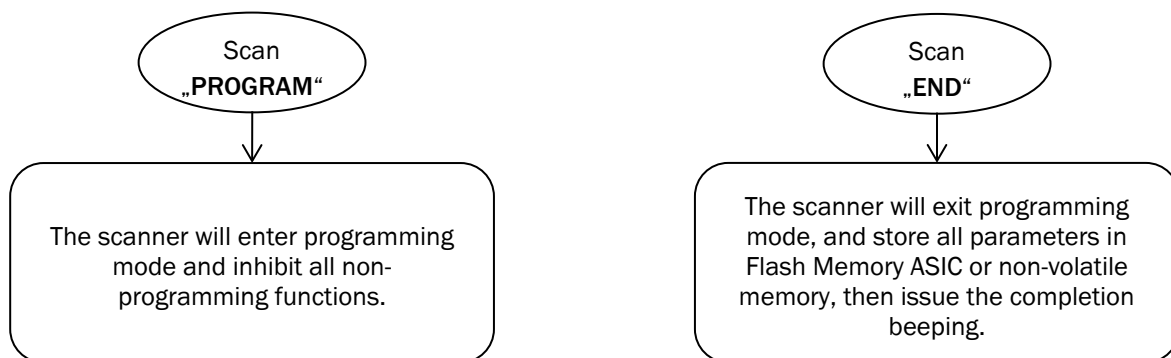

 Please note that the IDM Scanner will take 3-4 seconds to store parameters in internal Flash Memory ASIC or non-volatile memory after you scan the “END”. Please don’t turn off the power before the completion beeping. It may destroy all configured parameters.

3.2.2 System List & Master Default

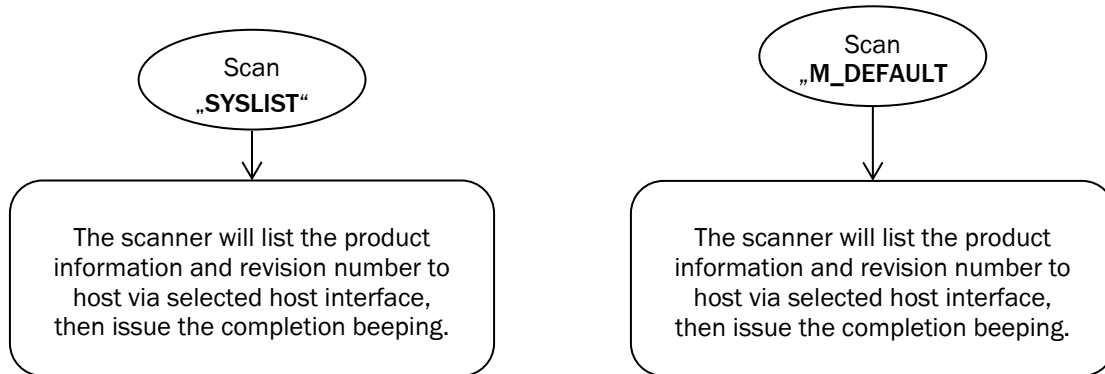

3.2.3 Single Scan

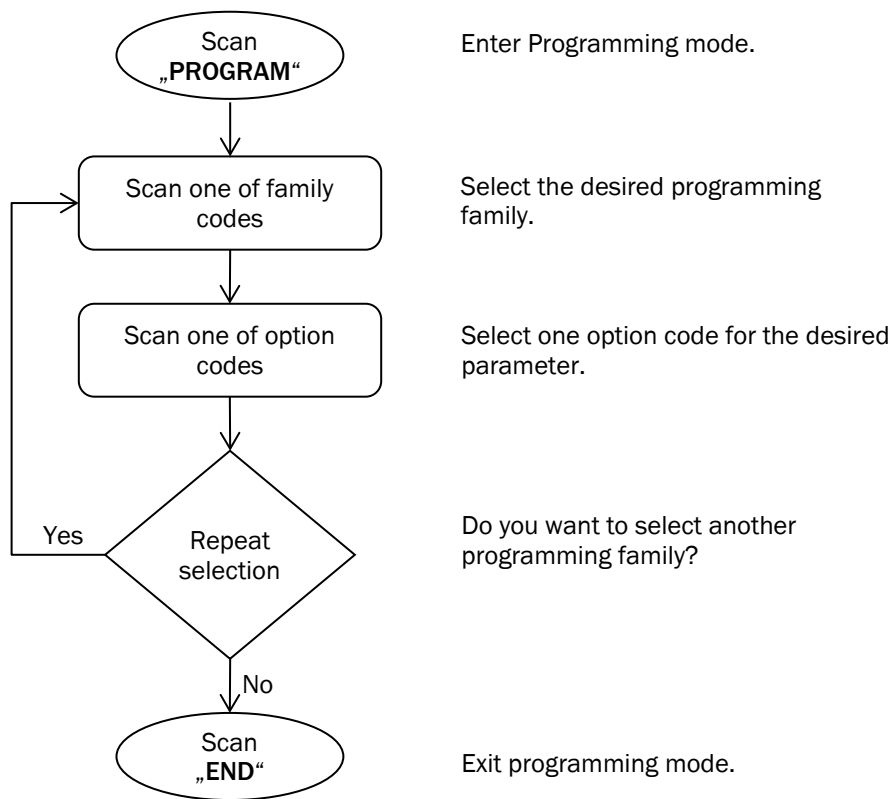

3.2.4 Multiple Scan

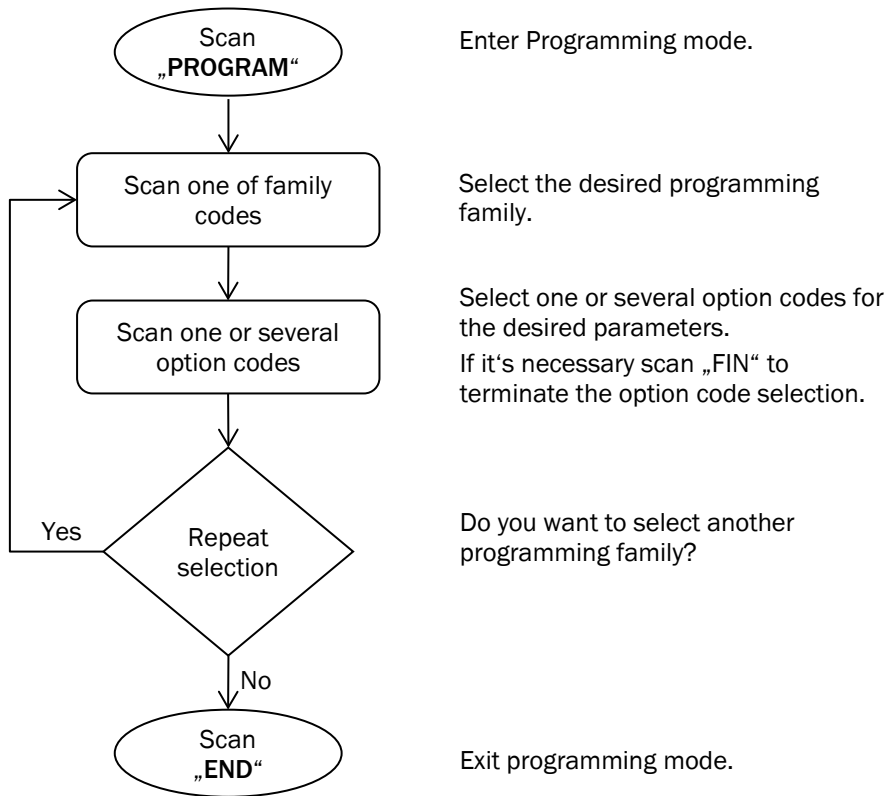

3.2.5 Cycling Scan

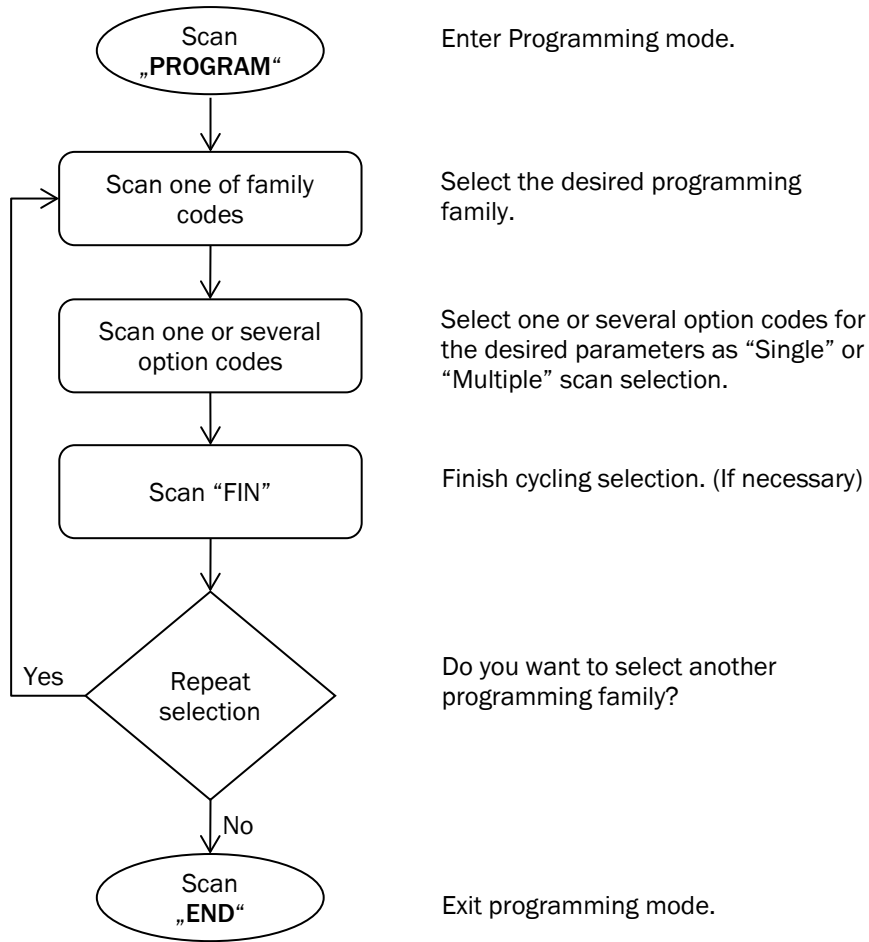

3.2.6 Dual Level Scan

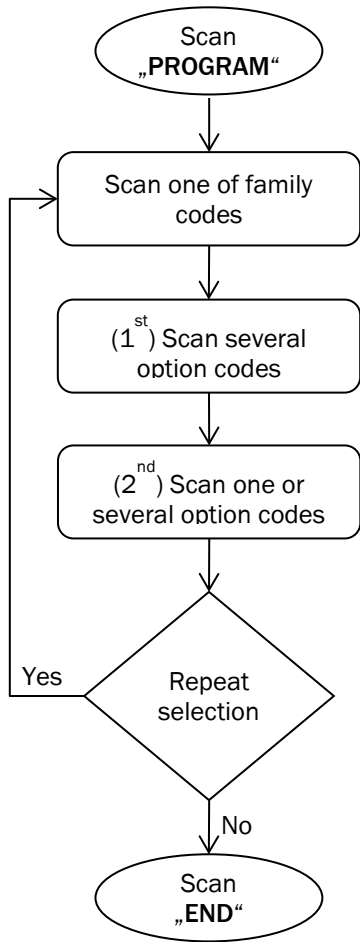

Enter Programming mode.

Select the desired programming family.

Select several option codes for the desired parameters.

1. Select one or several option codes for the desired parameters.
2. If it's necessary scan "FIN" to terminate the option code selection.

Do you want to select another programming family?

Exit programming mode.

3.3 Host Interface Selection



PROGRAM



F_DEFAULT

Family Code Selection	P.C.	Parameter Selection	Option Code
Host Interface Selection 	MS	IBM PS/2 25-30 series keyboard wedge interface	02
	MS	Standard/TTL RS-232 peer-to-peer serial	06
	MS	Wand Emulation	08
	MS	USB Com Port Emulation	09
	MS	PS/2 (DOS/V) direct link (keyboard replacement)	10
	MS	PS/2 (DOS/V) keyboard wedge turbo mode	13
	MS	PS/2 (DOS/V) keyboard wedge standard mode	14
	MS	Laser emulation	17
	MS	USB HID standard mode ◆	18
	MS	USB HID turbo mode	19
	MS	USB HID Legacy	20

 IDM2xx series doesn't support Wand emulation, Laser emulation and USB HID Legacy

3.4 Keyboard Interface Control

3.4.1 Keyboard Layout (Language)



PROGRAM



F_DEFAULT

Family Code Selection	P.C.	Parameter Selection	Option Code
Keyboard Layout 	SS	USA (QWERTY) ◆	00
	SS	France (AZERTY)	01
	SS	Germany (QWERTZ)	02
	SS	United Kingdom (QWERTY)	03
	SS	Canadian French (QWERTY)	04
	SS	Spain (Spanish, QWERTY)	05
	SS	Sweden/Finland (QWERTY)	06
	SS	Portugal (QWERTY)	07
	SS	Norway (QWERTY)	08
	SS	Spain (Latin America, QWERTY)	09
	SS	Italy (QWERTY)	10
	SS	Netherlands (QWERTY)	11
	SS	Denmark (QWERTY)	12
	SS	Belgium (AZERTY)	13
	SS	Switzerland-Germany (QWERTZ)	14
	SS	Iceland (QWERTY)	15
	SS	Japan (DOS/V)	16
SS	Czech (QWERTY)	17	

Please refer to the ASCII/HEX Table listed in the Appendix to determine the HEX codes for characters, symbols, and functions to be used as preamble or postamble.

To set preamble or postamble as function key output, you must enable the “Function Key Emulation” feature first.

Keyboard Interface Message String:

Preamble	Data Length	Prefix Symbol ID	Scanned Data	Suffix Symbol ID	Postamble	Record Suffix
1-15 characters	2-4 digits	1 or 3 characters	Variable length	1 or 3 characters	1-15 characters	1 character







3.4.2 Suffix, Preamble, Postamble, FNC1 Transmit, Caps Lock



PROGRAM



F_DEFAULT

Family Code Selection	P.C.	Parameter Selection	Option Code
Record Suffix 	SS	None	0
	SS	RETURN ◆	1
	SS	TAB ◆	2
	SS	SPACE	3
	SS	ENTER (Numeric Key Pad)	4
	SS	User defined character (1 character)	5, (00-7F)
Preamble 	SS	None ◆	FIN
	MS	1-15 characters	[00-7F], FIN
		Maximum 15-character input. Scan "FIN" to terminate this selection.	
Postamble 	SS	None ◆	FIN
	MS	1-15 characters	[00-7F], FIN
		Maximum 15-character input. Scan "FIN" to terminate this selection.	
FNC1 Symbol Char. Transmit 	SS	Disable ◆	0
	SS	Enable	1
Caps Lock Control 	SS	"Caps Lock Off" State ◆	0
	SS	"Caps Lock On" State	1
	SS	Auto Detect (PC/AT, PS/2, Keyboard Replacement and DOS/V Machines only)	2
Caps Lock Release Control 	SS	"Caps Lock On, Caps Off" ◆	0
	SS	"Caps Lock On, Shift Off"	1

FNC1 Symbol Character. Transmit

When this function is enabled and the FNC1 is contained in the scanned data, the scanner transmits the FNC1 to the host. When the scanner interface is set to keyboard, the scanned code is converted to corresponding key function before it is transmitted.

The function of "Caps Lock Control" and "Key Pad Emulation" are only available for IBM PC/AT, PS/VP, PS/2 series personal computers and compatible machines. While selecting the other host interfaces, these selections don't perform the above functions.

Please check the actual Caps Lock state in use while software application is running. If the Caps Lock state is off, select “Caps Lock Off” state, and then the Hand-held scanner will perform normal data transmission. If the Caps Lock state is on, select “Caps Lock On” state. If “Auto Detect” is selected, the Hand-held scanner will perform special transmission handshaking without changing the status of Caps Lock switch.



3.4.3 Delay Settings



PROGRAM



F_DEFAULT

Family Code Selection	P.C.	Parameter Selection	Option Code
Intermessage Delay 	SS	None ◆	FIN
	MS	01-99 (x5) msec.	(2 digits)
		Scan 2 digits from the option code chart in the Appendix; then the scanner will terminate this selection automatically.	
Intercharacter Delay 	SS	None ◆	FIN
	MS	01-99 (x5) msec.	(2 digits)
		Scan 2 digits from the option code chart in the Appendix; then the scanner will terminate this selection automatically.	
Interfunction Delay 	SS	None ◆	FIN
	MS	01-99 (x5) msec.	(2 digits)
		Scan 2 digits from the option code chart in the Appendix; then the scanner will terminate this selection automatically.	

Intermessage Delay: is a time delay between messages outputted by the Hand-held scanner. Increasing this delay will help host applications to process the incoming data on time.

Intercharacter Delay: is a time delay between data characters outputted by the Hand-held scanner. These two parameters are used to synchronize data communication when: 1) the data transmission speed is too fast, characters may be skipped; 2) multitasking operation system or host computers in a network may slow down the keyboard handling; 3) various notebook or desktop PC systems require different timing parameter settings. It is recommended to always add one extra unit as safety margin when adjusting these two parameters.

Interfunction Delay: is a time delay of between transmission and reception of each segment of the message string.



Intermessage, Intercharacter and Interfunction Delay are not available for IDM Bluetooth scanners working in SPP or HID mode.



3.4.4 Function Key & Key Pad Emulation, Upper/Lower Case



PROGRAM



F_DEFAULT

Family Code Selection	P.C.	Parameter Selection	Option Code
Function Key Emulation 	SS	Enable ASCII 00-31 code as keyboard function code output ◆	0
	SS	Ctrl-Output	1
		Refer to Appendix - Keyboard Function Code Table for details.	
Key Pad Emulation 	SS	Disable key pad emulation ◆	0
	SS	Enable numeric output as key pad (Num Lock On) output	1
Upper/ Lower Case 	SS	Normal case (neglect the upper/lower case control) ◆	0
	SS	Inverse case (change all characters output to inverse case)	1
	SS	Upper case (force all characters output as upper case)	2
	SS	Lower case (force all characters output as lower case)	3

3.5 Serial Interface Control





3.5.1 Suffix, Preamble, Postamble



PROGRAM



F_DEFAULT

Family Code Selection	P.C.	Parameter Selection	Option Code
STX/ ETX Control 	SS	Disable STX/ETX transmission ◆	0
	SS	Enable STX/ETX transmission	1
		STX/ETX are two characters used to indicate the starting and ending of the total data frame transmitted via serial interface.	
Record Suffix 	SS	None	0
	SS	CR (0DH) ◆	1
	SS	LF (0AH)	2
	SS	CRLF (0DOAH)	3
	SS	TAB (09H)	4
	SS	SPACE (20H)	5
Preamble 	SS	None ◆	FIN
	MS	1-15 characters	[00-7F], FIN
		Maximum 15-character input; scan "FIN" to terminate this selection.	
Postamble 	SS	None ◆	FIN
	MS	1-15 characters	[00-7F], FIN
		Maximum 15-character input; scan "FIN" to terminate this selection.	
FNC1 Symbol Char. Transmit 	SS	Disable	0
	SS	Enable ◆	1
		When this function is enabled and the FNC1 is contained in scanned data, the scanner transmits the FNC1 to the host. A chart of the FNC1 is provided in the Appendix – Keyboard Function Code Table. When the scanner interface is set to keyboard, the scanned code is converted to corresponding key function before it is transmitted.	

Serial Interface Message String (RS-232, USB COM)

STX	Preamble	Data Length	Prefix Symbol ID	Scanned Data	Suffix Symbol ID	Postamble	ETX	Record Suffix
1 character	1-15 characters	2-4 digits	1 or 3 characters	Variable length	1 or 3 characters	1-15 characters	1 character	1 character

3.5.2 Delay Settings



PROGRAM



F_DEFAULT

Family Code Selection	P.C.	Parameter Selection	Option Code
Intermessage Delay 	SS	None ◆	FIN
	MS	01-99 (x5) msec.	(2 digits)
		Scan 2 digits from the option code chart in the Appendix; then the scanner will terminate this selection automatically.	
Intercharacter Delay 	SS	None ◆	FIN
	MS	01-99 (x5) msec.	(2 digits)
		Scan 2 digits from the option code chart in the Appendix; then the scanner will terminate this selection automatically.	
Interfunction Delay 	SS	None ◆	FIN
	MS	01-99 (x5) msec.	(2 digits)
		Scan 2 digits from the option code chart in the Appendix; then the scanner will terminate this selection automatically.	

Intermessage Delay: is a time delay between messages outputted by the Hand-held scanner. Increasing this delay will help host applications to process the incoming data on time.

Intercharacter Delay: is a time delay between data characters outputted by the Hand-held scanner. These two parameters are used to synchronize data communication when: 1) the data transmission speed is too fast, characters may be skipped; 2) multitasking operation system or host computers in a network may slow down the keyboard handling; 3) various notebook or desktop PC systems require different timing parameter settings. It is recommended to always add one extra unit as safety margin when adjusting these two parameters.

Interfunction Delay: is a time delay of between transmission and reception of each segment of the message string.



Intermessage, Intercharacter and Interfunction Delay are not available for IDM Bluetooth scanners working in SPP or HID mode.



3.5.3 Handshaking Protocol, ACK/ NAK



PROGRAM



F_DEFAULT

Family Code Selection	P.C.	Parameter Selection	Option Code
Handshaking Protocol 	SS	None (free running mode) ◆	0
	SS	RTS/CTS (hardware handshaking)	1
	SS	ACK/NAK (software handshaking)	2
	SS	Xon/Xoff (software handshaking)	3
NAK Retry Count 	SS	3 times ◆	FIN
	SS	000-255 times	(3 digits)
ACK Indication 	SS	Disable ACK Time-out Indication	0
	SS	Enable ACK Time-out Indication ◆	1
	SS	Disable ACK Indication ◆	2
	SS	Enable ACK Indication	3

- USB COM doesn't support RTS/CTS handshaking protocol.
- When the **RTS/CTS Hardware Handshaking** option is selected, the RTS (request to send) and CTS (clear to send) signals will be issued before normal data communication. This option is very helpful to ensure the reliability of data communication.
- When the **ACK/NAK Software Handshaking** option is selected, the Hand-held scanner waits for an ACK (acknowledge) or NAK (not acknowledge) from the host computer after each data transmission. If the NAK is received, the Hand-held scanner will re-send the data until receiving ACK. (This function is not available for IDM Bluetooth Scanners in PICO or HID Mode.)

NAK Retry Count

After transmitting data, the scanner expects a NAK response from the host up to the preset "Serial Response Time-out". If the scanner doesn't get a response, the scanner will issue an error indication and discard the data. When a NAK is received, the scanner transmits the same data again and waits for either an ACK or NAK. The scanner issues an error indication and discards the data under following two conditions:

1. After preset NAK retry counts is received within the preset serial response time-out.
2. If the preset time-out is up but the preset NAK retry counts haven't come to the end.

The default retry counts are three times. If you program "0 times", the scanner will not resend the data to the host when the scanner receives a NAK. The scanner will discard the data. If you program "255 times", the scanner can receive unlimited NAKs from the host within the pre-set serial response time-out.

This function is not available for batch mode. When you enable this function in on-line mode, the out-of-range function will be disabled automatically.

ACK Indication

Disable: There's neither LED nor beeping indication for this setting.

Enable: There's a specific LED and beeping indication for this setting.



3.5.4 Response Time-out, Baud Rate



PROGRAM



F_DEFAULT

Family Code Selection	P.C.	Parameter Selection	Option Code
Serial Response Time-out 	SS	None	0
	SS	200 mseconds	1
	SS	500 mseconds ◆	2
	SS	800 mseconds	3
	SS	1 second	4
	SS	2 seconds	5
	SS	3 seconds	6
	SS	4 seconds	7
	SS	5 seconds	8
	SS	8 seconds	9
	SS	10 seconds	A
	SS	15 seconds	B
Baud Rate (BPS) 	SS	38.4K BPS	0
	SS	19.2K BPS	1
	SS	9600 BPS ◆	2
	SS	4800 BPS	3
	SS	2400 BPS	4
	SS	1200 BPS	5
	SS	57.6K BPS	8
	SS	115.2K BPS	9

The Serial Response Time-out is a pre-defined delay time for the Hand-held scanner to wait for handshaking, acknowledgment or non-acknowledgment from the host computer

3.5.5 Data Frame



PROGRAM



F_DEFAULT

Family Code Selection	P.C.	Parameter Selection	Option Code
Data Frame 	SS	8, None, 1 ♦	0
	SS	8, Odd, 1	1
	SS	8, Even, 1	2
	SS	8, None, 2	5
	SS	7, Odd, 1	6
	SS	7, Even, 1	7
	SS	7, Space, 1	8
	SS	7, Mark, 1	9
	SS	7, None, 2	A
	SS	7, Odd, 2	B
	SS	7, Even, 2	C
	SS	7, Space, 2	D
	SS	7, Mark, 2	E

3.6 Wand/ Laser Emulation Control (IDM1xx series)

3.6.1 Output Polarity, Signal State, Margin/ Module Time



PROGRAM



F_DEFAULT

Family Code Selection	P.C.	Parameter Selection	Option Code
Output Polarity 	SS	High level (5Vdc) on Bar (low level on Space) ◆	0
	SS	Low level (0Vdc) on Bar (high level on Space)	1
		Determine the output voltage level for both bar and space.	
Initial Signal State 	SS	High Level (5Vdc) ◆	0
	SS	Low Level (0Vdc)	1
		Determine the initial state of output voltage level.	
Margin Time 	SS	10 msec.	0
	SS	15 msec.	1
	SS	20 msec. ◆	2
	SS	25 msec.	3
	SS	30 msec.	4
Module Time 	SS	Extremely short	0
	SS	Short	1
	SS	Medium ◆	2
	SS	Long	3
Narrow/ Wide ratio 	SS	1:2 ◆	0
	SS	1:2.5	1
	SS	1:3	2
Code 39/ Code 128 Emulation 	SS	Disable standard Code 39 emulation ◆	0
	SS	Enable standard Code 39 skip emulation	1
	SS	Enable standard Code 39 replace emulation	2
	SS	Enable Full ASCII Code 39 emulation	3
	SS	Enable Code 128 emulation	4

Code 39 Skip

When this option is selected, all scanned data will be translated as Standard Code 39 wand/laser emulation output. If any lower case characters are read, they will be translated to upper case characters. Any other characters that are not available in Code 39 symbology set will be skipped.

Code 39 Replace

Any character not normally available in the standard Code 39 symbology set will be translated as Space.

3.7 Symbology Reading Control

3.7.1 User Defined Symbol ID



PROGRAM



F_DEFAULT

Family Code Selection	P.C.	Parameter Selection	1 st Option Code	2 nd Option Code
Symbol ID 1 character 	DS	Code 128 (default=B)	00	(1 character)
		GS1-128 (default=C)	01	(1 character)
		UPC-A (default=A)	02	(1 character)
		EAN-13 (default=F)	03	(1 character)
		Codabar/NW-7 (default=D)	04	(1 character)
		Code 39/Code 32 (default=G)	05	(1 character)
		Code 93 (default=H)	06	(1 character)
		Standard/Industrial 2 of 5 (default=I)	07	(1 character)
		Interleaved 2 of 5 (default=J)	08	(1 character)
		Matrix 2 of 5 (default=K)	09	(1 character)
		China Postal Code (default=L)	10	(1 character)
		German Postal Code (default=M)	11	(1 character)
		IATA (default=O)	12	(1 character)
		Code 11 (default=P)	13	(1 character)
		MSI/Plessey (default=R)	14	(1 character)
		UK/Plessey (default=S)	15	(1 character)
		Telepen (default=T)	16	(1 character)
		GS1 DataBar (default=X)	17	(1 character)
		UPC-E (default=E)	18	(1 character)
		EAN-8 (default=N)	19	(1 character)
		Trioptic Code 39 (default=W)	20	(1 character)
		UCC Coupon Extended Code (default=Z)	21	(1 character)
		PDF417/Micro PDF417 (default=V)	22	(1 character)
		Codablock F (default=Y)	23	(1 character)
		Code 16K (default=Q)	24	(1 character)
		Code 49 (default=U)	25	(1 character)
Korea Post Code (default=a)	26	(1 character)		



PROGRAM



F_DEFAULT

Family Code Selection	P.C.	Parameter Selection	Option Code	2nd Option Code
Symbol ID 1 character 	DS	QR & Micro QR Code (default=b)	28	(1 character)
		Data Matrix (default=c)	29	(1 character)
		Australian Post (default=g)	33	(1 character)
		British Post (default=h)	34	(1 character)
		Intelligent Mail (USPS 4CB/One Code) (default=j)	36	(1 character)
		Japan Post (default=k)	37	(1 character)
		Netherlands KIX Post (default=l)	38	(1 character)
		US Planet (default=m)	39	(1 character)
		US Postnet (default=o)	41	(1 character)

3.7.2 Symbology ID Transmission



PROGRAM



F_DEFAULT

Family Code Selection	P.C.	Parameter Selection	Option Code
Symbology ID Transmission 	SS	Disable symbology ID transmission ◆	0
	SS	Enable prefix SICK symbology ID transmission	1
	SS	Enable suffix SICK symbology ID transmission	2
	SS	Enable both prefix and suffix SICK symbology ID transmission	3
	SS	Enable prefix AIM symbology ID transmission	4
	SS	Enable suffix AIM symbology ID transmission	5
	SS	Enable both prefix and suffix AIM symbology ID transmission	6

3.7.3 Readable Bar Codes

If your application is known, you may select those known symbologies only to increase the reading speed and decrease the possibility of reading error. Furthermore, adding the “Symbology ID” into the transmitted data is also helpful to identify the specific symbology.



PROGRAM



F_DEFAULT

Family Code Selection	P.C.	Parameter Selection	Option Code
Readable Symbology  Remember to scan “FIN” after you terminate this section (Cycling Scan). If you choose “Auto” (Single Scan) you don’t need to scan “FIN”.	SS	Auto ◆	00
	CS	Code 128 *	01
	CS	GS1-128	31
	CS	UPC-A	02
	CS	UPC-E *	03
	CS	EAN-13 *	04
	CS	EAN-8 *	05
	CS	Codabar/NW-7 *	06
	CS	Code 39 *	07
	CS	Trioptic Code 39	47
	CS	Standard/Industrial 2 of 5	08
	CS	Matrix 2 of 5	38
	CS	Interleaved 2 of 5 *	48
	CS	China Postal Code	58
	CS	Germany Postal Code	68
	CS	Code 93 *	09
	CS	Code 11	10
	CS	MSI/Plessey	11
	CS	UK/Plessey	12
	CS	Telepen	13
	CS	GS1 DataBar (RSS-14) *	14
CS	IATA	15	
CS	Coupon Code	16	
CS	PDF417 * /Micro PDF417	17	
CS	Codablock F	18	
CS	Code 16K	19	
CS	Code 49	20	
CS	Korea Post Code	21	



PROGRAM



F_DEFAULT

Family Code Selection	P.C.	Parameter Selection	Option Code
Readable Symbology 	CS	QR Code */ Micro QR Code *	A0
	CS	Data Matrix *	A1
	CS	Aztec Code *	A3
	CS	Australian Post	B0
	CS	British Post	B1
	CS	Intelligent Mail barcode	B3
	CS	Japanese Post	B4
	CS	KIX Post	B5
	CS	Planet Code	B6
	CS	Postnet	B8

Above symbologies marked with * are enabled as default. When you select “Auto”, the scanner only reads those symbologies marked with *. When you set the minimum and maximum length of each symbology, please note the data length of the scanned bar code doesn’t include start/stop characters.

3.7.4 Code 39/ Code 32



PROGRAM



F_DEFAULT

Family Code Selection	P.C.	Parameter Selection	Option Code
Code 39 Family Setting 	SS	Disable Code 39	0
	SS	Enable Code 39 ◆	1
	SS	Select Standard Code 39 as primary format ◆	2
	SS	Select Full ASCII Code 39 as primary format	3
	SS	Select Code 32 (PARAF, Italian Pharmaceutical) as primary format	4
	SS	Disable start/stop symbol transmission ◆	5
	SS	Enable start/stop symbol transmission	6
	SS	Disable Code 32 leading A transmission ◆	7
	SS	Enable Code 32 leading A transmission	8
	SS	Disable MOD 43 check digit verification ◆	9
	SS	Enable MOD 43 check digit verification	A
	SS	Disable check digit transmission ◆	B
	SS	Enable check digit transmission	C
	SS	Disable Code 39 buffering ◆	D
SS	Enable Code 39 buffering	E	
Trioptic Code 39 Setting 	SS	Disable Trioptic Code 39 ◆	0
	SS	Enable Trioptic Code 39	1
Code 39 Min. Length 	SS	Default (01) ◆	FIN
	MS	01-98	(2 digits)
		Scan 2 digits from the option code chart in the Appendix; then the scanner will terminate this selection automatically.	
Code 39 Max. Length 	SS	Default (98) ◆	FIN
	MS	01-98	(2 digits)
		Scan 2 digits from the option code chart in the Appendix; then the scanner will terminate this selection automatically.	

Trioptic Code 39 and Code 39 Full ASCII cannot be enabled simultaneously.

3.7.5 Code 39



PROGRAM



F_DEFAULT

Family Code Selection	P.C.	Parameter Selection	Option Code
Code 39 Security Level 	SS	Level 0	0
	SS	Level 1	1
	SS	Level 2 ♦	2
	SS	Level 3	3

Code 39 Security Level

The scanner offers four levels of decode security for Code 39 bar codes:

- **Level 0:** If you are experiencing misread of poorly-printed or serious out-of-spec. bar codes in level 1 please select level 0.
- **Level 1:** If you are experiencing misread of poorly-printed or out-of-spec. bar codes in level 2, please select level 1.
- **Level 2:** This is the default setting which allows the scanner to operate fastest, while providing sufficient security in decoding “in-spec” Code 39 bar codes.
- **Level 3:** If you failed to read poorly-printed or out-of-spec. bar codes in level 2, please select level 3. This is the most aggressive setting and may increase the misread.





3.7.6 Codabar/ NW-7



PROGRAM



F_DEFAULT

Family Code Selection	P.C.	Parameter Selection	Option Code
Codabar Settings 	SS	Disable Codabar	0
	SS	Enable Codabar ◆	1
	SS	Select Codabar standard format ◆	2
	SS	Select Codabar ABC format	3
	SS	Select Codabar CLSI format	4
	SS	Select Codabar CX format	5
	SS	Disable start/stop symbol transmission ◆	6
	SS	Enable ABCD/ABCD start/stop symbol transmission	7
	SS	Enable abcd/abcd start/stop symbol transmission	8
	SS	Enable ABCD/TN*E start/stop symbol transmission	9
	SS	Enable abcd/tn*e start/stop symbol transmission	A
	SS	Disable check digit verification ◆	B
	SS	Enable check digit verification	C
	SS	Disable check digit transmission ◆	D
SS	Enable check digit transmission	E	
Codabar Check Digit Settings 	SS	Modulus 16 ◆	0
	SS	Modulus 10/weight 3	1
	SS	Modulus 11	2
	SS	Modulus 10/weight 2	3
	SS	7 check DR	4
	SS	Weight Modulus 11	5
	SS	Runes (Modulus 10/weight 2)	6
Codabar Min. Length 	SS	Default (04) ◆	FIN
	MS	01-98	(2 digits)
		Scan 2 digits from the option code chart in the Appendix; then the scanner will terminate this selection automatically.	
Codabar Max. Length 	SS	Default (98) ◆	FIN
	MS	01-98	(2 digits)
		Scan 2 digits from the option code chart in the Appendix; then the scanner will terminate this selection automatically.	

3.7.7 UPC-A/ UPC-E



PROGRAM



F_DEFAULT

Family Code Selection	P.C.	Parameter Selection	Option Code
UPC-A Family Settings 	SS	Disable UPC-A	0
	SS	Enable UPC-A ◆	1
	SS	Disable UPC-E	2
	SS	Enable UPC-E ◆	3
	SS	Disable UPC-E expansion ◆	4
	SS	Enable UPC-E expansion	5
	SS	Disable UPC standardization ◆	6
	SS	Enable UPC standardization	7
	SS	Disable UPC numeric system	8
	SS	Enable UPC numeric system ◆	9
	SS	Disable UPC-A check digit transmission	A
	SS	Enable UPC-A check digit transmission ◆	B
	SS	Disable UPC-E check digit transmission	C
	SS	Enable UPC-E check digit transmission ◆	D
	SS	Disable UPC “leading 1” portion ◆	E
SS	Enable UPC “leading 1” portion	F	

 When enable UPC-E expansion, the UPC-E decoded data will be converted to UPC-A format and affected by related settings, such as UPC standardization, UPC numeric system and UPC-A check digit transmission.

UPC-E & EAN-8 Expansion: Expand the 8-digit UPC-E and 8-digit ENA-8 to 12-digit UPC-A and 13-digit EAN-13.

UPC-A Standardization: Expand the 12-digit UPC-A to 13-digit EAN-13 with 1 zero insertion.

UPC Lead 1 Numeric System: To read UPC leading with the 1 numeric system, you must enable this option.



WPC Selection (UPC/EAN/CAN)	Basic Length	Disable Check Digit	Disable Numeric System	With 2-digit Addendum	With 5-digit Addendum	Enable Standardization	Enable Expansion
UPC-A	12	- 1	- 1	+ 2	+ 5	+ 1	0
UPC-E	8	- 1	- 1	+ 2	+ 5	+ 1	+ 4
EAN-13	13	- 1	NC	+ 2	+ 5	NC	0
EAN-8	8	- 1	NC	+ 2	+ 5	NC	+ 5



PROGRAM



F_DEFAULT

Family Code Selection	P.C.	Parameter Selection	Option Code
UPC Supplement Settings 	SS	Select UPC without supplement digits ◆	0
	SS	Select UPC with only 2 supplement digits	1
	SS	Select UPC with only 5 supplement digits	2
	SS	Select UPC with 2/5 supplement digits	3
	SS	Disable force supplement digits output ◆	4
	SS	Enable force supplement digits output	5
	SS	UPC Family Addenda Separator Off ◆	6
	SS	UPC Family Addenda Separator On	7
UPC/ EAN Security Level 	SS	Level 0	0
	SS	Level 1 ◆	1
	SS	Level 2	2
		Only available for UPC-A & EAN-13	
Supplement Scan Vorting 	SS	None	0
	SS	Level 1	1
	SS	Level 2	2
	SS	Level 3 ◆	3
	SS	Level 4	4
	SS	Level 5	5
	SS	Level 6	6
	SS	Level 7	7
	SS	Level 8	8
	SS	Level 9	9
	SS	Level 10	A
	SS	Level 11	B
	SS	Level 12	C
	SS	Level 13	D

UPC/EAN Security Level

The scanner offers three levels of decode security for UPC/EAN bar codes:

- **Level 0:** If you are experiencing misread of poorly-printed or out-of-spec. bar codes, especially in characters 1, 2, 7, and 8 in level 1, please select level 0. Selection of this security level may significantly impair the decoding ability of the scanner.
- **Level 1:** This is the default setting which allows the scanner to operate fastest, while providing sufficient security in decoding “in-spec” UPC/EAN bar codes.

- **Level 2:** If you are experiencing misread of poorly-printed, soiled or damage bar codes in level 1, please select level 2. This is the most aggressive setting and may increase the misread.

Supplement Scan Voting

The Supplement Scan Voting is the number of times the same UPC/EAN with 2/5 supplement digits has to be decoded before it is transmitted. It is helpful when decoding a mix of UPC/EAN symbols with and without supplement digits. This function is effective when you select UPC/EAN with only 2 supplement digits, UPC/EAN with only 5 supplement digits or UPC/EAN with 2/5 supplement digits. The default value is Level 3. When you select a higher level, it may impact the reading speed on poorly-printed, low contrast or damaged barcode labels.



3.7.8 EAN Code



PROGRAM



F_DEFAULT

Family Code Selection	P.C.	Parameter Selection	Option Code
EAN Settings 	SS	Disable EAN-13	0
	SS	Enable EAN-13 ◆	1
	SS	Disable EAN-8	2
	SS	Enable EAN-8 ◆	3
	SS	Disable EAN-8 expansion ◆	4
	SS	Enable EAN-8 expansion	5
	SS	Disable EAN-13 check digit transmission	6
	SS	Enable EAN-13 check digit transmission ◆	7
	SS	Disable EAN-8 check digit transmission	8
	SS	Enable EAN-8 check digit transmission ◆	9
	SS	Disable ISBN/ISSN Conversion reading check ◆	A
	SS	Enable ISBN/ISSN Conversion reading check	B
EAN Supplement Settings 	SS	Select EAN without supplement digits ◆	0
	SS	Select EAN with only 2 supplement digits	1
	SS	Select EAN with only 5 supplement digits	2
	SS	Select EAN with 2/5 supplement digits	3
	SS	Disable force supplement digits output ◆	4
	SS	Enable force supplement digits output	5
	SS	EAN Addenda Separator Off ◆	6
	SS	EAN Addenda Separator On	7
Supplement Scan Vorting 	SS	None	0
	SS	Level 1	1
	SS	Level 2	2
	SS	Level 3 ◆	3
	SS	Level 4	4
	SS	Level 5	5
	SS	Level 6	6
	SS	Level 7	7
	SS	Level 8	8
	SS	Level 9	9
	SS	Level 10	A
	SS	Level 11	B
	SS	Level 12	C
SS	Level 13	D	

Supplement Scan Voting



The Supplement Scan Voting is the number of times the same UPC/EAN with 2/5 supplement digits has to be decoded before it is transmitted. It is helpful when decoding a mix of UPC/EAN symbols with and without supplement digits. This function is effective when you select UPC/EAN with only 2 supplement digits, UPC/EAN with only 5 supplement digits or UPC/EAN with 2/5 supplement digits. The default value is Level 3. When you select a higher level, it may impact the reading speed on poorly-printed, low contrast or damaged barcode labels.



PROGRAM



F_DEFAULT

Family Code Selection	P.C.	Parameter Selection	Option Code
EAN Supplement Control 	SS	Disable all specific prefix supplement digital output ◆	0
	SS	Enable all specific prefix supplement digital output	1
	SS	Enable 491 Supplement Digit Output	2
	SS	Enable 978/979 Supplement Digit Output	3
	SS	Enable 977 Supplement Digit Output	4
	SS	Enable 378/379 Supplement Digit Output	5
	SS	Enable 414/419 Supplement Digit Output	6
	SS	Enable 434/439 Supplement Digit Output	7
UPC/ EAN Security Level 	SS	Level 0	0
	SS	Level 1 ◆	1
	SS	Level 2	2
		Only available for UPC-A & EAN-13	

EAN Supplement Control

If you select EAN with only 2 or 5 or 2/5 supplement digits and enable 491 prefix supplement digit output, the scanner will transmit EAN with 2, or 5 or 2/5 supplement digits bar codes starting with 491 prefix. The EAN without supplement digit **will not be** transmitted.

If you select EAN with only 2 or 5 or 2/5 supplement digits and enable the other except 491 prefix supplement digit output, the scanner will transmit EAN with 2, or 5, or 2/5 supplement digits bar codes starting with specific prefix. The EAN without supplement digit **will be** transmitted.

UPC/EAN Security Level

The scanner offers three levels of decode security for UPC/EAN bar codes:

- **Level 0:** If you are experiencing misread of poorly-printed or out-of-spec. bar codes, especially in characters 1, 2, 7, and 8 in level 1, please select level 0. Selection of this security level may significantly impair the decoding ability of the scanner.
- **Level 1:** This is the default setting which allows the scanner to operate fastest, while providing sufficient security in decoding “in-spec” UPC/EAN bar codes.
- **Level 2:** If you are experiencing misread of poorly-printed, soiled or damage bar codes in level 1, please select level 2. This is the most aggressive setting and may increase the misread.

3.7.9 UCC Coupon Extended Code



PROGRAM



F_DEFAULT

Family Code Selection	P.C.	Parameter Selection	Option Code
UCC Coupon Extended Code Setting 	SS	Disable UCC Coupon Extended Code ◆	0
	SS	Enable UCC Coupon Extended Code	1

UCC Coupon Extended Code

When UCC coupon extended code function is enabled, scanner decodes UPC-A barcodes starting with digit “5”, EAN-13 barcodes starting with digit “99” and GS1-128 Coupon Codes. UPC-A, EAN-13 and EAN-128 must be enabled to scan all types of Coupon Codes.



3.7.10 IATA & Interleaved 2 of 5



PROGRAM



F_DEFAULT

Family Code Selection	P.C.	Parameter Selection	Option Code
IATA Settings 	SS	Disable IATA ◆	0
	SS	Enable IATA	1
	SS	Select 15-digit fixed length IATA checking ◆	2
	SS	Select variable length IATA	3
	SS	Disable check digit verification ◆	4
	SS	Enable check digit automatic verification	5
	SS	Enable S/N checking digit verification only	6
	SS	Enable CPN checking digit verification only	7
	SS	Enable CPN, Airline and S/N check digit verification	8
	SS	Disable check digit transmission ◆	9
	SS	Enable check digit transmission	A
	SS	Disable start/stop symbol transmission ◆	B
	SS	Enable start/stop symbol transmission	C
Interleaved 2 of 5 Settings 	SS	Disable Interleaved 2 of 5	0
	SS	Enable Interleaved 2 of 5 ◆	1
	SS	Select Interleaved 2 of 5 as primary format ◆	2
	SS	Select German Postal Code as primary format	3
	SS	No check character ◆	4
	SS	Validate USS check digit	5
	SS	Validate OPCC check digit	6
	SS	Disable check digit transmission ◆	7
	SS	Enable check digit transmission	8



3.7.11 Code 25 Family



PROGRAM



F_DEFAULT

Family Code Selection	P.C.	Parameter Selection	Option Code
Code 25 Settings 	SS	Disable Standard/Industrial 2 of 5 ◆	0
	SS	Enable Standard/Industrial 2 of 5	1
	SS	Disable Matrix 2 of 5 ◆	2
	SS	Enable Matrix 2 of 5	3
	SS	Disable China Postal Code ◆	4
	SS	Enable China Postal Code	5
	SS	Disable check digit verification ◆	6
	SS	Enable check digit verification	7
	SS	Disable check digit transmission ◆	8
	SS	Enable check digit transmission	9
Code 25 Family Min. Length 	SS	Default (04) ◆	FIN
	MS	01-98	(2 digits)
		Scan 2 digits from the option code chart in the Appendix; then the scanner will terminate this selection automatically.	
Code 25 Family Max. Length 	SS	Default (98) ◆	FIN
	MS	01-98	(2 digits)
		Scan 2 digits from the option code chart in the Appendix; then the scanner will terminate this selection automatically.	

 For Code25 setting, we recommend you to select only one type of Code 25 or set the maximum/minimum bar code length. To decode all types of Code 25 or to variable length of Code 25 will increase the possibility of reading error.







3.7.12 Code 11 & Code 93



PROGRAM



F_DEFAULT

Family Code Selection	P.C.	Parameter Selection	Option Code
Code 11 Settings 	SS	Disable Code 11 ◆	0
	SS	Enable Code 11	1
	SS	Disable check digit verification ◆	2
	SS	Select 1-check digit verification	3
	SS	Select 2-check digit verification	4
	SS	Disable check digit transmission ◆	5
	SS	Enable check digit transmission	6
Code 11 Min. Length 	SS	Default (04) ◆	FIN
	MS	01-98	(2 digits)
		Scan 2 digits from the option code chart in the Appendix; then the scanner will terminate this selection automatically.	
Code 11 Max. Length 	SS	Default (98) ◆	FIN
	MS	01-98	(2 digits)
		Scan 2 digits from the option code chart in the Appendix; then the scanner will terminate this selection automatically.	
Code 39 Settings 	SS	Disable Code 93	0
	SS	Enable Code 93 ◆	1
	SS	Disable check digit transmission ◆	2
	SS	Enable check digit transmission	3
Code 39 Min. Length 	SS	Default (01) ◆	FIN
	MS	01-98	(2 digits)
		Scan 2 digits from the option code chart in the Appendix; then the scanner will terminate this selection automatically.	
Code 39 Max. Length 	SS	Default (98) ◆	FIN
	MS	01-98	(2 digits)
		Scan 2 digits from the option code chart in the Appendix; then the scanner will terminate this selection automatically.	



3.7.13 MSI/ Plessey



PROGRAM



F_DEFAULT

Family Code Selection	P.C.	Parameter Selection	Option Code
MSI/ Plessey Settings 	SS	Disable MSI/Plessey ◆	0
	SS	Enable MSI/Plessey	1
	SS	Select MOD 10 check digit ◆	2
	SS	Select MOD 10-10 check digit	3
	SS	Select MOD 11-10 check digit	4
	SS	Disable check digit transmission ◆	5
	SS	Enable check digit transmission	6
MSI/ Plessey Min. Length 	SS	Default (04) ◆	FIN
	MS	01-98	(2 digits)
		Scan 2 digits from the option code chart in the Appendix; then the scanner will terminate this selection automatically.	
MSI/ Plessey Max. Length 	SS	Default (98) ◆	FIN
	MS	01-98	(2 digits)
		Scan 2 digits from the option code chart in the Appendix; then the scanner will terminate this selection automatically.	





3.7.14 Code 128



PROGRAM



F_DEFAULT

Family Code Selection	P.C.	Parameter Selection	Option Code
Code 128 Settings 	SS	Disable Code 128	0
	SS	Enable Code 128 ◆	1
	SS	ISBT Concatenation Off ◆	2
	SS	ISBT Concatenation On	3
Code 128 Min. Length 	SS	Default (01) ◆	FIN
	MS	01-98	(2 digits)
		Scan 2 digits from the option code chart in the Appendix; then the scanner will terminate this selection automatically.	
Code 128 Max. Length 	SS	Default (98) ◆	FIN
	MS	01-98	(2 digits)
		Scan 2 digits from the option code chart in the Appendix; then the scanner will terminate this selection automatically.	
Code 128 Security Level 	SS	Level 0	0
	SS	Level 1 ◆	1

Code 128 Security Level

The scanner offers two levels of decode security for Code128 bar codes:

- Level 0: If you are experiencing misread of poor-printed or out-of-spec. bar codes in level 1, please select level 0.
- Level 1: This is the default setting which allows the scanner to operate fastest, while providing sufficient security in decoding "in-spec." Code 128 bar codes.





3.7.15 GS1-128



PROGRAM



F_DEFAULT

Family Code Selection	P.C.	Parameter Selection	Option Code
GS1-128 Family Setting 	SS	Disable GS1-128 special function ◆	0
	SS	Enable GS1-128 special function	1
	SS	Disable First FNC1 transmission ◆	2
	SS	Enable First FNC1 convert to “]C1” and transmission	3
	SS	Disable Application Identifier output ◆	4
	SS	Enable Application Identifier output	5
	SS	Enable Application Identifier output with additional “()”	6
	SS	Disable “DD=00” transmission when AI data field contains the date	7
	SS	Enable “DD=00” transmission when AI data field contains the date ◆	8
	SS	Disable a dot insert in the decimal point position ◆	9
	SS	Enable a dot inset in the decimal point position	A
GS1-128 Min. Length 	SS	Default (01) ◆	FIN
	MS	01-Maximum	(2 digits)
		Scan 2 digits from the option code chart in the Appendix; then the scanner will terminate this selection automatically.	
GS1-128 Max. Length 	SS	Default (98) ◆	FIN
	MS	98-Minimum	(2 digits)
		Scan 2 digits from the option code chart in the Appendix; then the scanner will terminate this selection automatically.	
GS1-128 Edition Mode 	SS	None ◆	FIN
	MS	1 – 10 Application Identifier (AIs) and Prefix, Suffix input	[AI table] ¹ , [GS1-128 ASCII table] ² , [FIN]
		Please scan the AI barcodes and ASCII barcodes in your desired output sequence.	
GS1-128 Edition Mode Output Control 	SS	If the application identifier set in edition mode is not found, only the Header Terminator Separator is output ◆	0
	SS	If the application identifier set in edition mode is not found, the Header Terminator Separator is not output.	1
	If option 1 is chosen, the following settings can be applied:		
	SS	If data was completely un-match, do not output original data	2
	SS	If data was completely un-match, output original data ◆	3

¹ For the Application Identifier (AI) table see chapter 5.6 on page 103







² For the GS1-128 ASCII table see chapter 5.5 on page 100



PROGRAM



F_DEFAULT

Family Code Selection	P.C.	Parameter Selection	Option Code
GS1-128 Element String Separator 	SS	None ◆	FIN
	SS	User defined character (1~2 characters)	[GS1-128 ASCII Table] ¹ , [FIN]
GS1-128 Data Separator 	SS	None ◆	FIN
	MS	User defined character (1~2 characters)	[GS1-128 ASCII Table] ¹ , [FIN]
GS1-128 FNC1 since the second transmission setting 	SS	None ◆	0
	MS	GS (1DH)	1
	MS	User defined character (1~2 characters)	2, [GS1-128 ASCII Table] ¹ , [FIN]
GS1-128 Error Output Setting 	SS	Anything doesn't output the error when Code 128 is converted into GS1-128 ◆	0
	SS	When Code 128 makes an error converting into GS1-128, it outputs as Code 128	1
		When the decode is not done as GS1-128	
GS1 DataBar Output Control 	SS	Disable GS1 DataBar (RSS-14) output application identifier with additional “()” ◆	0
	SS	Enable GS1 DataBar (RSS-14) output application identifier with additional “()”	1
Record Suffix USB (HID) I/F, AT wedge I/F 	SS	None ◆	0
	SS	RETURN	5, [GS1-128 ASCII: 94] ¹ , [FIN]
	SS	TAB	5, [GS1-128 ASCII: 8C] ¹ , [FIN]
	SS	SPACE	3
	SS	User defined character (1 character)	5, [GS1-128 ASCII Table] ¹ , [FIN]



GS1-128 special function list



Scanning this barcode shows the GS1-128 special function settings.

¹ For the GS1-128 ASCII table see chapter 5.5 on page 100



3.7.16 UK/ Plessey



PROGRAM



F_DEFAULT

Family Code Selection	P.C.	Parameter Selection	Option Code
UK/ Plessey Settings 	SS	Disable UK/Plessey ◆	0
	SS	Enable UK/Plessey	1
	SS	Select UK/Plessey Standard Format ◆	2
	SS	Select UK/Plessey CLSI Format	3
	SS	Disable Convert X to A-F ◆	4
	SS	Enable Convert X to A-F	5
	SS	Disable check digit transmission ◆	6
	SS	Enable check digit transmission	7
UK/ Plessey Min. Length 	SS	Default (04) ◆	FIN
	MS	01-98	(2 digits)
		Scan 2 digits from the option code chart in the Appendix; then the scanner will terminate this selection automatically.	
UK/ Plessey Max. Length 	SS	Default (98) ◆	FIN
	MS	01-98	(2 digits)
		Scan 2 digits from the option code chart in the Appendix; then the scanner will terminate this selection automatically.	



3.7.17 Telepen



PROGRAM



F_DEFAULT

Family Code Selection	P.C.	Parameter Selection	Option Code
Telepen Settings 	SS	Disable Telepen ◆	0
	SS	Enable Telepen	1
	SS	Select Telepen Numeric mode ◆	2
	SS	Select Telepen Full ASCII mode	3
	SS	Disable check digit transmission ◆	4
	SS	Enable check digit transmission	5
Telepen Min. Length 	SS	Default (04) ◆	FIN
	MS	01-98	(2 digits)
		Scan 2 digits from the option code chart in the Appendix; then the scanner will terminate this selection automatically.	
Telepen Max. Length 	SS	Default (98) ◆	FIN
	MS	01-98	(2 digits)
		Scan 2 digits from the option code chart in the Appendix; then the scanner will terminate this selection automatically.	



3.7.18 GS1 DataBar



PROGRAM



F_DEFAULT

Family Code Selection	P.C.	Parameter Selection	Option Code
GS1 DataBar Settings 	SS	Disable GS1 DataBar (RSS-14)	0
	SS	Enable GS1 DataBar (RSS-14) ◆	1
	SS	Disable GS1 DataBar Limited	2
	SS	Enable GS1 DataBar Limited ◆	3
	SS	Disable GS1 DataBar Expanded	4
	SS	Enable GS1 DataBar Expanded ◆	5
GS1 DataBar Min. Length 	SS	Default (04) ◆	FIN
	MS	01-74	(2 digits)
		Only available for Expanded GS1 DataBar. Scan 2 digits from the option code chart in the Appendix; then the scanner will terminate this selection automatically.	
GS1 DataBar Max. Length 	SS	Default (74) ◆	FIN
	MS	01-74	(2 digits)
		Only available for Expanded GS1 DataBar. Scan 2 digits from the option code chart in the Appendix; then the scanner will terminate this selection automatically.	



3.7.19 Composite Codes, Codablock F, PDF417, Micro PDF417



PROGRAM



F_DEFAULT

Family Code Selection	P.C.	Parameter Selection	Option Code
Composite Codes Settings 	SS	Disable composite codes ◆	0
	SS	Enable composite codes	1
	SS	UPC Composite Mode: UPC never linked ◆	2
	SS	UPC Composite Mode: UPC always linked	3
			If “UPC Composite Mode: UPC never linked” is selected, UPC barcodes are transmitted whether Micro PDF417 symbol is detected or not. If “UPC Composite Mode: UPC always linked” is selected, UPC barcodes are only transmitted when the Micro PDF417 is detected.
Codablock F Settings 	SS	Disable ◆	0
	SS	Enable	1
PDF417/ Micro PDF417 Settings 	SS	Disable PDF417	0
	SS	Enable PDF417 ◆	1
	SS	Disable MicroPDF417 ◆	2
	SS	Enable MicroPDF417	3







3.7.20 Code 16K & Code 49



PROGRAM



F_DEFAULT

Family Code Selection	P.C.	Parameter Selection	Option Code
Code 16K Settings 	SS	Disable Code 16K ◆	0
	SS	Enable Code 16K	1
Code 16K Min. Length 	SS	Default (01) ◆	FIN
	MS	001-160	(3 digits)
		Scan 3 digits from the option code chart in the Appendix; then the scanner will terminate this selection automatically.	
Code 16K Max. Length 	SS	Default (160) ◆	FIN
	MS	001-160	(3 digits)
		Scan 3 digits from the option code chart in the Appendix; then the scanner will terminate this selection automatically.	
Code 49 Settings 	SS	Disable Code 49 ◆	0
	SS	Enable Code 49	1
Code 49 Min. Length 	SS	Default (01) ◆	FIN
	MS	01-81	(2 digits)
		Scan 2 digits from the option code chart in the Appendix; then the scanner will terminate this selection automatically.	
Code 49 Max. Length 	SS	Default (81) ◆	FIN
	MS	01-81	(2 digits)
		Scan 2 digits from the option code chart in the Appendix; then the scanner will terminate this selection automatically.	



3.7.21 QR Code



PROGRAM



F_DEFAULT

Family Code Selection	P.C.	Parameter Selection	Option Code
QR Code Settings 	SS	Disable QR Code	0
	SS	Enable QR Code ◆	1
	SS	Disable MicroQR Code	2
	SS	Enable MicroQR Code ◆	3
	SS	Disable QR Code Append	4
	SS	Enable QR Code Append ◆	5
	SS	Disable QR Code Inverse Reading ◆	6
	SS	Enable QR Code Inverse Reading	7
	SS	Auto detect QR Code Inverse Reading	8
QR Code Min. Length 	SS	Default (0001) ◆	FIN
	MS	0001-7089	(4 digits)
		Scan 4 digits from the option code chart in the Appendix; then the scanner will terminate this selection automatically.	
QR Code Max. Length 	SS	Default (7089) ◆	FIN
	MS	0001-7089	(4 digits)
		Scan 4 digits from the option code chart in the Appendix; then the scanner will terminate this selection automatically.	



3.7.22 Data Matrix



PROGRAM



F_DEFAULT

Family Code Selection	P.C.	Parameter Selection	Option Code
Data Matrix Settings 	SS	Disable Data Matrix	0
	SS	Enable Data Matrix ◆	1
	SS	Disable Data Matrix Inverse Reading	4
	SS	Enable Data Matrix Inverse Reading	5
	SS	Auto Detect Data Matrix Inverse Reading ◆	6
	SS	Disable Data Matrix Mirror Images	7
	SS	Enable Data Matrix Mirror Images	8
	SS	Auto Detect Data Matrix Mirror Images ◆	9
Data Matrix Min. Length 	SS	Default (0001) ◆	FIN
	MS	0001-3116	(4 digits)
		Scan 4 digits from the option code chart in the Appendix; then the scanner will terminate this selection automatically.	
Data Matrix Max. Length 	SS	Default (3116) ◆	FIN
	MS	0001-3116	(4 digits)
		Scan 4 digits from the option code chart in the Appendix; then the scanner will terminate this selection automatically.	



3.7.23 Aztec Code



PROGRAM



F_DEFAULT

Family Code Selection	P.C.	Parameter Selection	Option Code
Aztec Code Settings 	SS	Disable Aztec Code	0
	SS	Enable Aztec Code ◆	1
Aztec Code Min. Length 	SS	Default (0001) ◆	FIN
	MS	0001-3832	(4 digits)
		Scan 4 digits from the option code chart in the Appendix; then the scanner will terminate this selection automatically.	
Aztec Code Max. Length 	SS	Default (3832) ◆	FIN
	MS	0001-3832	(4 digits)
		Scan 4 digits from the option code chart in the Appendix; then the scanner will terminate this selection automatically.	





3.7.24 Autralian Post, US Planet, US Postnet, British Post, Japan Post



PROGRAM



F_DEFAULT

Family Code Selection	P.C.	Parameter Selection	Option Code
Australian Post Settings 	SS	Disable Australian Post ◆	0
	SS	Enable Australian Post	1
	SS	Raw format Output ◆	2
	SS	Numeric Encoding Output (N Encoding Table)	3
	SS	Alphanumeric Encoding Output (C Encoding Table)	4
	SS	Auto-discriminate Output (Combination C & N Encoding Table)	5
US Planet Settings 	SS	Disable US Planet ◆	0
	SS	Enable US Planet	1
	SS	Disable Check Digit Transmission ◆	2
	SS	Enable Check Digit Transmission	3
US Postnet Settings 	SS	Disable US Postnet ◆	0
	SS	Enable US Postnet	1
	SS	Disable Check Digit Transmission ◆	2
	SS	Enable Check Digit Transmission	3
British Post Settings 	SS	Disable British Post ◆	0
	SS	Enable British Post	1
	SS	Disable Check Digit Transmission ◆	2
	SS	Enable Check Digit Transmission	3
Japan Post Settings 	SS	Disable Japan Post ◆	0
	SS	Enable Japan Post	1

Australian Post Setting

Auto-discriminate output option increases the risk of misread because the encoded data format does not specify the encoding table used for encoding.



3.7.25 Netherland KIX Code, Intelligent Mail & Korea Post Code



PROGRAM



F_DEFAULT

Family Code Selection	P.C.	Parameter Selection	Option Code
Netherlands KIX Code Settings 	SS	Disable Netherlands KIX Code ◆	0
	SS	Enable Netherlands KIX Code	1
Intelligent Mail Settings (USPS 4CB/ One Code) 	SS	Disable Intelligent Mail ◆	0
	SS	Enable Intelligent Mail	1
Korea Post Code Settings 	SS	Disable Korea Post Code ◆	0
	SS	Enable Korea Post Code	1
		Length fixed in 6 characters.	

3.7.26 DPM Code

If you own a DPM model (IDMxxx-x2xx) you can enable or disable the DPM code reading functionality by scanning one of the following barcode commands.



Enable DPM functionality ◆



Disable DPM functionality

In order to verify if the DPM functionality is enabled, please scan the following barcode. If you can read this barcode, the DPM functionality is enabled.



Test1



IDM Corded scanners: if you scan “factory default” and afterwards disconnect the scanner from your host device, the DPM functionality will be disabled automatically.

IDM Bluetooth scanners: if you take out the battery the DPM functionality will be disabled automatically.

If you disable the DPM functionality the performance of reading printed 1D and 2D codes will be improved.

3.8 Operation Mode

3.8.1 Corded scanners (IDMxx0 series)



PROGRAM



F_DEFAULT

Family Code Selection	P.C.	Parameter Selection	Option Code	
			1D scanner (IDM1x0)	2D scanner (IDM2x0)
Operation Mode 	SS	Low Power mode (Low power triggering)	0	0
	SS	Trigger mode (External triggering) ◆	1	1
	SS	Presentation mode (Auto detection)	2	2
	SS	Alternative mode (Periodic power off)	3	3
	SS	Flash mode	4	-
	SS	Force mode (Continued power on)	5	4
	SS	Toggle mode (Repeat reading)	6	5
	SS	Diagnostic mode (Test reading)	7	6
	SS	Level mode (Auto power off)	8	7
	SS	Multiple Read Mode	-	8

Low Power Mode (Low Power Triggering)

The scanner goes into idle state after scanning the barcode. You must press the trigger to wake up the scanner for operation. It is very helpful for mobile data collection and applications, which are concerned with power saving.

Trigger Mode (External Triggering)

The scanner goes into standby state after scanning the barcode. You must press the trigger to turn on the light source of the scanner before scanning the bar code.

Presentation Mode (Auto Detection)

Presentation mode uses ambient light to detect the barcodes. The light source is off until the scanner detects an image which is similar to a barcode. Then the light source turns on automatically to read the bar code. If the light level in the room is not high enough, Presentation Mode may not work properly. You can choose different level of “Presentation Sensitivity” to meet your application’s requirements. (Please refer to the setting of “Presentation Sensitivity” on page 79.)

Alternative Mode (Periodic Power Off)

The scanner keeps the light source of the scanner turned on till the pre-defined light source on time is up. After the scanner turns off the light source, you must press the trigger to turn on the light source again. After each good read, the timer counter of “Light Source on Time” is reset. For you do not have to press the trigger frequently it is very convenient for multiple scanning.

Flash Mode (Pulse Driven Reading)

The scanner flashes the light source of the scanner without using the trigger. If the scanner detects an image which is similar to a barcode, the scanner forces on the light source automatically and scans the barcode. Flash Duty Cycle adjustment can change the frequency of the blinking.

Force Mode (Continued Power On)

The light source of the scanner is forced on for continued operation without pressing the trigger button. This mode is convenient for high speed bar code reading.

Toggle Mode (Repeat Reading)

The toggle mode is very similar to the Alternative Mode but without the pre-defined light source on time concern. You must press the trigger to turn on the light source of the scanner to scan. The scanner keeps the light source turned on until you press the trigger again.

Diagnostic Mode (Test Reading)

This operation mode is specifically designed for diagnostic purposes. When this operation mode is selected, the light source of the scanner is force on without regard for other programmable parameters, such as reread delay, redundancy, and so forth.

Level Mode (Auto Power Off)

When this operation mode is selected, the scanner continues to turn on the light source of the scanner before a good read or pre-defined “Light Source on Time”. If the scanner decodes a barcode successfully, it turns off the light source immediately. After the scanner turns off the light source, you must press the trigger to turn on the light source again. If there is no scanning operation performed during the pre-defined light source on time, the scanner enters the idle state after the pre-defined light source on time is up.

3.8.2 Bluetooth scanners (IDMxx1 series)



PROGRAM



F_DEFAULT

Family Code Selection	P.C.	Parameter Selection	Option Code
Operation Mode 	SS	Trigger mode ◆	1
	SS	Presentation mode	2

3.9 Operation Control

3.9.1 Buzzer, Power On LED, Good read indicator, Vibrator Control



PROGRAM



F_DEFAULT

Family Code Selection	P.C.	Parameter Selection	Option Code
Buzzer Tone Adjust 	SS	Buzzer tone – mute	0
	SS	Buzzer tone – low	1
	SS	Buzzer tone – medium ♦	2
	SS	Buzzer tone – high	3
	SS	Buzzer tone - extremely high	4
	SS	Power-on beep ♦	5
	SS	No power-on beep	6
Power On Indicator 	SS	Disable (LED off)	0
	SS	LED steady on ♦	1
	SS	LED flash	2
		IDM120 series doesn't support this function.	
Good Read Indicator 	SS	Disable	0
	SS	Enable ♦	1
Vibrator Control 	SS	Disable	0
	SS	Enable ♦	1
		Only available for industrial series (IDMx6x).	



3.9.2 Dollar Sign, Redundancy, 1D Code Inverse Reading



PROGRAM



F_DEFAULT

Family Code Selection	P.C.	Parameter Selection	Option Code
Dollar Sign Control 	SS	Dollar sign output as “\$” ◆	0
	SS	Dollar sign output as “¥”	1
	SS	Dollar sign output as “€”	2
	SS	Dollar sign output as “£”	3
	SS	Dollar sign output as “¢”	4
Redundancy 	SS	None	0
	SS	Level 1 ◆	1
	SS	Level 2	2
	SS	Level 3	3
	SS	Level 4	4
	SS	Level 5	5
		The Redundancy is the number of times the same barcode has to be decoded before it is transmitted. (To prevent potential misreading.)	
1D Barcode Inverse Reading 	SS	Disable ◆	0
	SS	Enable	1



3.9.3 Reread Delay, Good Read Delay Control



PROGRAM



F_DEFAULT

Family Code Selection	P.C.	Parameter Selection	Option Code
Reread Delay (Double Scan Verification) 	SS	Disable	0
	SS	Immediate time out ◆	1
	SS	Short time out	2
	SS	Medium time out	3
	SS	Long time out	4
	SS	Force verification	5
Good Read Delay 	SS	None ◆	0
	SS	200 msec.	1
	SS	500 msec.	2
	SS	1 sec.	3
	SS	1.5 sec.	4
	SS	2 sec.	5
	SS	3 sec.	6

The Reread Delay (Double Scan Verification)

This function is designed to inhibit the Hand-held scanner from reading the same bar code label twice in pre-defined short duration. Force Verification will not allow the reading of the same bar code twice.



IDM1x0: The Reread Delay function is only available when using the Hands-free stand.

IDM2x0: The Reread Delay function is only available in Multiple Read mode or when using the Hands-free stand.

Good Read Delay

This Good Read Delay is the minimum amount of time before the Hand-held scanner can read another barcode.





3.9.4 Light Source On Time, Hands Free Time-out



PROGRAM



F_DEFAULT

Family Code Selection	P.C.	Parameter Selection	Option Code
Light Source On Time 	SS	Short (◆ for IDM corded)	0
	SS	Medium	1
	SS	Long (◆ for IDM Bluetooth)	2
	SS	Extremely long	3
Hands-free Time Out 	SS	Short ◆	0
	SS	Medium	1
	SS	Long	2
	SS	Extremely long	3
	SS	Disable	4
Good Read Duration 	SS	Short ◆	0
	SS	Medium	1
	SS	Long	2
	SS	Extremely long	3
	SS	Extremely short	4
Time Delay to Low Power Mode 	SS	1 sec.	0
	SS	3 sec.	1
	SS	5 sec.	2
	SS	7 sec.	3
	SS	9 sec.	4
	SS	Immediate ◆	5

Light Source On Time

This function is a pre-defined light source time out counter for Alternative Mode, Presentation Mode and Level Mode. The scanner keeps the light source on till the pre-defined light source on time is up.

Hands-free Time Out

The Presentation Mode, Force Mode and Flash Mode are referred to as “Hands-free” mode. The Hands-free mode will be automatically changed to manual trigger mode when you press the trigger. You can remain the scanner in manual trigger mode by setting the Hands Free Time-Out. Once the time-out duration is up (if there isn’t any trigger operation), the imager will revert to the original hands free mode.

Time Delay to Low Power Mode

This function sets the time for the scanner to enter low power mode after any scanning activity. For corded scanners this setting is only available if the scanner is in low power mode.

3.9.5 Presentation Auto-Sense, Sensitivity



PROGRAM



F_DEFAULT

Family Code Selection	P.C.	Parameter Selection	Option Code
Presentation Auto-sense 	SS	Disable	0
	SS	Enable ◆	1
Presentation Sensitivity 	SS	Level 1	0
	SS	Level 2	1
	SS	Level 3	2
	SS	Level 4	3
	SS	Level 5 ◆	4
	SS	Level 6	5
	SS	Level 7	6

Presentation Auto sense

When enabling the Presentation Auto-sense, the scanner can switch automatically from hand-held to hands-free scanning when working with the Hands-free stand or cradle.

Presentation Sensitivity

The presentation sensitivity is used to configure the sensitivity level when the scanner is set as presentation mode. The higher lever means higher sensitivity for detecting the barcode.



3.9.6 Presentation Control, Scan Rate, Flash Duty



PROGRAM



F_DEFAULT

Family Code Selection	P.C.	Parameter Selection	Option Code			
			1D Corded (IDM1x0)	2D Corded (IDM2x0)	1D BT (IDM1x1)	2D BT (IDM2x1)
Presentation Control 	SS	Presentation mode ◆	0	0	-	-
	SS	Flash mode	1	-	-	-
	SS	Force mode	2	1	-	-
Scan Rate Control 	SS	Dynamic ◆	0	-	0	-
	SS	Fixed	1	-	1	-
Flash Duty Cycle 	SS	1/2 duty cycle ◆	0	-	-	-
	SS	2/3 duty cycle	1	-	-	-
	SS	3/4 duty cycle	2	-	-	-
	SS	4/5 duty cycle	3	-	-	-

Presentation Control

When the scanner is placed on the Hands-free stand, the scanner will be switched from hand-held scanning to hands-free scanning automatically. Three hands-free scanning modes are available. You are recommended to use flash mode or force mode while under insufficient ambient light.

Scan Rate Control

The scanner will have better motion tolerance when you select “Fixed” scan rate. It’s suitable for applications which need higher motion tolerance on the move. But this may impact to the reading distance.

Flash Duty Cycle

The Flash Duty Cycle is designed to control the flashing frequency of the light source.



3.9.7 Illumination Control, Presentation Background Lighting



PROGRAM



F_DEFAULT

Family Code Selection	P.C.	Parameter Selection	Option Code			
			1D Corded (IDM1x0)	2D Corded (IDM2x0)	1D BT (IDM1x1)	2D BT (IDM2x1)
Illumnation Control 	SS	Disable	-	0	-	0
	SS	Enable ◆	-	1	-	1
		Not available for presentation, force and diagnostic mode				
Presentation Background Lighting 	SS	LEDs Off	-	0	-	0
	SS	LEDs On ◆	-	1	-	1

Presentation Background Lighting Control: You can enable or disable presentation background lighting of the scanner according to the ambient light condition in presentation mode. When the ambient light is dim or dark, you can enable this function to turn on the scanner’s LED illumination at a dim level. This is helpful to detect the motion of scene.



3.9.8 Aiming, Delay Aiming Time-out, Decode Aiming



PROGRAM



F_DEFAULT

Family Code Selection	P.C.	Parameter Selection	Option Code			
			1D Corded (IDM1x0)	2D Corded (IDM2x0)	1D BT (IDM1x1)	2D BT (IDM2x1)
Aiming Control 	SS	Regular Aiming (◆ for IDM BT)	-	0	-	0
	SS	Intelligent Aiming (◆ for IDM corded)	-	1	-	1
	SS	Delay Aiming Control	-	2	-	2
Delay Aiming Time-out Control 	SS	200 ms	-	0	-	0
	SS	400 ms ◆	-	1	-	1
	SS	800 ms	-	2	-	2
	SS	1 sec	-	3	-	3
	SS	1.5 secs.	-	4	-	4
	SS	2 secs.	-	5	-	5
	SS	3 secs.	-	6	-	6
	SS	4 secs.	-	7	-	7
Decode Aiming Control 	SS	Disable in Hand-Held mode	-	0	-	0
	SS	Enable in Hand-Held mode ◆	-	1	-	1
	SS	Disable in Hands-Free mode	-	2	-	2
	SS	Enable in Hands-Free mode ◆	-	3	-	3

Aiming Control

The Aiming Control is only available for trigger mode. In Intelligent Aiming, the aiming light is turned on when the scanner is lifted. A trigger pull activates decoding process. After 2 seconds of inactivity, the aiming light will be shut off. Delay Aiming Control allows a delay time for the operator to aim the scanner before the image is taken. During the delay time, the aiming light will be on, but the LED illumination won't be turned on until the delay time is up.

Delay Aiming Time-out Control

The Delay Aiming Time-out Control is only available for trigger mode. You can use Delay Aiming Time-out Control to set the delay time.

Decode Aiming Control

For IDM260, this function is not supported in Hands-Free mode.

Hand-Held mode: Low power, Trigger, Alternative, Toggle, Level & Multiple read mode

Hands-Free mode: Presentation mode, Force mode, Diagnostic mode



3.9.9 Center Alignment, Unique Barcode Reporting



PROGRAM



F_DEFAULT

Family Code Selection	P.C.	Parameter Selection	Option Code			
			1D Corded (IDM1x0)	2D Corded (IDM2x0)	1D BT (IDM1x1)	2D BT (IDM2x1)
Center Alignment 	SS	Disable in Hand-Held mode ◆	-	0	-	0
	SS	Enable in Hand-Held mode	-	1	-	1
	SS	Disable in Hands-Free mode ◆	-	2	-	2
	SS	Enable in Hands-Free mode	-	3	-	3
Unique Barcode Reporting 	SS	Disable ◆	-	0	-	0
	SS	Enable	-	1	-	1

Center Alignment

When this function is enabled, the scanner only decodes barcode(s) around the aiming line.

Unique Bar Code Reporting

When this function is enabled, the scanner only outputs unique barcodes when the trigger is pressed. This function is workable when Multiple Read mode is selected.

Hand-Held mode: Low power mode, Trigger mode, Alternative mode, Toggle mode, Level mode, Multiple read mode

Hands-Free mode: Presentation mode, Force mode, Diagnostic mode



3.9.10 1D Barcode Reading Direction



PROGRAM



F_DEFAULT

Family Code Selection	P.C.	Parameter Selection	Option Code			
			1D Corded (IDM1x0)	2D Corded (IDM2x0)	1D BT (IDM1x1)	2D BT (IDM2x1)
1D Barcode Forward-reading Indication 	SS	None ◆	0	-	-	-
	SS	“S”	1	-	-	-
	MS	User defined character (1 character)	2, [00-7F]	-	-	-
1D Barcode Backward-reading Indication 	SS	None ◆	0	-	-	-
	SS	“X”	1	-	-	-
	MS	User defined character (1 character)	2, [00-7F]	-	-	-
1D Barcode Direction Indication Transmission 	SS	Disable ◆	0	-	-	-
	SS	Enable prefix direction mark transmission	1	-	-	-
	SS	Enable suffix direction mark transmission	2	-	-	-
	SS	Enable both prefix and suffix direction mark transmission	3	-	-	-

3.10 Bluetooth Operation Control (IDM Bluetooth series)



3.10.1 Out-of-range Scanning, Link Supervision Time-Out, Beeping Control



PROGRAM



F_DEFAULT

Family Code Selection	P.C.	Parameter Selection	Option Code
Out-of-range Scanning 	SS	Disable ◆	0
	SS	Enable	1
Link Supervision Time-out 	SS	1 sec	0
	SS	3 secs ◆	1
	SS	5 secs	2
	SS	7 secs	3
	SS	9 secs	4
		Only available in PAIR & PICO mode	
Beeping Control 	SS	Radio connected/ disconnected Beep On ◆	0
	SS	Radio connected/ disconnected Beep Off	1
	SS	Battery Power Low Beep On ◆	2
	SS	Battery Power Low Beep Off	3

Out-of-range Scanning

When radio link is built between the scanner and remote host device, the scanner will transmit each scanned data right after scanning the barcode data. The scanner is preset to not scan any barcode data when it loses the radio connection. You can enable the Out-of-range Scanning function to continue scanning barcode data into the internal memory buffer until radio link resumed.

Link Supervision Time-out

This is a pre-defined radio link supervision timeout setting. The scanner will supervise the radio link status every preset seconds.



3.10.2 Sleep Time-out, Power Off Time-out



PROGRAM



F_DEFAULT

Family Code Selection	P.C.	Parameter Selection	Option Code
Sleep Time-out of connected state 	SS	6 (x5) minutes ◆	FIN
	MS	0-99 (x5) minutes	(2 digits)
		If you don't want the scanner to enter sleep mode, please set time-out to "0".	
Sleep Time-out of disconnected state 	SS	1 minute ◆	FIN
	MS	0-99 minutes	(2 digits)
		If you don't want the scanner to enter sleep mode, please set time-out to "0".	
Power Off Time-Out 	SS	6 (x5) minutes ◆	FIN
	MS	0-12 minutes	(2 digits)
		If you don't want the scanner to enter power off mode, please set time-out to "0".	

Sleep Time-out control

The sleep time-out control can be set under radio connection or disconnection state. If the scanner is not used within the preset time-out duration, it will automatically enter "Sleep Mode" for power saving purpose. You can disable this function by setting the time-out duration to "0".

Power off Time-out control

When the scanner is under sleep mode, it is preset to enter "Power Off" automatically if it is not woken up after time-out duration. If you would like to wake up the scanner press the trigger button. Meanwhile you can disable this function by setting the time-out duration to "0".







3.10.3 Bluetooth Batch Scanning



PROGRAM



F_DEFAULT

Family Code Selection	P.C.	Parameter Selection	Option Code
Batch Scanning Link Control 	SS	Radio disable	0
	SS	Radio enable ◆	1
Stored Data Transmission 	SS	Either on cradle or by scanning barcode	0
	SS	On cradle	1
	SS	Scan barcode ◆	2
Delete Stored Data after Transmission 	SS	Disable ◆	0
	SS	Enable	1
Field Delimiter 	SS	None	0
	SS	, ◆	1
	SS	SPACE	2
	SS	-	3
	SS	.	4
	SS	User define	5, [00-7F]
Batch Data Quantity Output Format 	SS	As many times as the quantity indicates ◆	0
	SS	<Quantity><Field Delimiter><Scanned Data>	1
	SS	<Scanned Data><Field Delimiter><Quantity>	2
Data Transmission Format 	SS	Disable (scanned data only) ◆	0
	SS	Leading with MAC address (MAC address & scanned data)	1
	SS	Leading with ID No. (Scanner ID & scanned data)	2
		Only available for RS-232, USB HID and USB COM interface in PAIR & PICO mode.	

Batch Scanning Link Control

It's a predefined radio option to control the radio-on or radio-off status under batch scanning operation. Please note that if "Radio disable" is selected, the radio link will be disconnected once you enter batch scanning. The radio link will be resumed when you transmit the stored data or exit batch scanning.

Stored Data Transmission

It's a predefined approach when you want to transmit the scanned data under batch scanning operation. You can transmit the scanned data by placing the scanner onto the cradle or scanning "Transmit Stored Data" command (refer to chapter 2.7.3) or by either one of both methods.

Delete Stored Data after Transmission

This function is disabled in the factory default setting. The scanner will keep all stored data after transmission until you scan the "Clear all Stored Data" command (refer to chapter 2.7.4). If you enable this function all stored data will automatically be deleted after transmission.

Field Delimiter

This function is used to separate the specific information and the scanned data into two fields. You can choose the delimiter format.

Batch Data Quantity Output Format

If you want to input the quantity information of the scanned barcode data, you can enter the quantity from 1 to 9999 by scanning the quantity barcodes right after scanning the barcode data. The quantity information will be stored into the memory storage together with the barcode data. There are three ways to output the stored barcode data and quantity information. (Also refer to chapter 2.7.1)

Data Transmission Format

In PICO mode up to seven scanners can be connected to one smart cradle. The Data Transmission Format helps to identify the source of the transmitted data. Example format: <MAC address><Field delimiter><Data> or <ID><Field delimiter><Data>.



3.10.4 Bluetooth Device name, Security Settings



PROGRAM



F_DEFAULT

Family Code Selection	P.C.	Parameter Selection	Option Code
Bluetooth Device Name 	SS	Default device name ◆	FIN
	MS	User defined IDM1xx: 1-16 characters IDM2xx: 1-32 characters	[00-7F], FIN
		The default device name is: IDMxxx	
Bluetooth PIN Code 	SS	Default Bluetooth PIN Code ◆	FIN
	MS	User defined (1-8 numbers)	[30-39], FIN
		The default PIN code is: 00000000	
Bluetooth Authentication 	SS	Disable	0
	SS	Enable ◆	1

Bluetooth Authentication

You can enable or disable the Bluetooth Authentication between the scanner and remote host device. If this function is enabled, when the scanner wants to connect itself and sends the data to the host device, the host device has to return a link key shared between the scanner and the host device.



3.10.5 HID Link Quality, Power Saving Mode



PROGRAM



F_DEFAULT

Family Code Selection	P.C.	Parameter Selection	Option Code
HID Link Quality Setting 	SS	Disable	0
	SS	Enable ◆	1
Bluetooth Power Saving Mode 	SS	Disable ◆	0
	SS	Enable	1

HID Link Quality Setting

While using the HID radio link mode, some errors may occur during the data transmission when the radio link is disconnected. You can enable this function to prevent such errors.

Bluetooth Power Saving Mode

The Bluetooth scanner will enter low power consumption mode when you enable this function.

3.11 Batch Reading (IDM2xx series)



PROGRAM



F_DEFAULT

Family Code Selection	P.C.	Parameter Selection	Option Code
Batch reading 	SS	None ◆	FIN
	SS	Batch reading rule input (01-16 rules)	[Rules], FIN

Batch Reading

When this function is enabled, you can scan multiple barcodes one by one continuously upon one trigger event. The scanner reports a good read beep and indication only if all bar codes set by the “Batch Reading Rule” are read. Otherwise, the scanner reports an error beep and indication. The scanned data will be transmitted according to the preset sequence which is defined in “Batch Reading Rule” regardless the scanned order of those barcodes.

 Batch Reading function is only available for 2D Hand-held scanners (IDM2xx series).

Batch Reading function is only available in Trigger Mode.

Batch Reading is not available when Multiple Read Mode or Center Alignment is turned on.

Batch Reading Rule

To set the Batch Reading rule:

1. Scan the PROGRAM code.
2. Scan the Batch Reading Family Code.
3. Use the Option Codes to define the preset Batch Reading rule.
4. Scan the FIN symbol.
5. Scan the END symbol to save your Batch Reading rule.

 Scan the ABORT and END code to exit without saving any Batch Reading rule setting.

When you scan “None”, the preset Batch Reading Rule will be deleted.

Batch Reading Rule Syntax

The Syntax is: *[n] [Element 1] FF [Element 2] FF [Element 3] FF ... [Element n] FF*

Where *n* is the number of elements in the overall rule. The number of elements is limited to 16.

FF indicates the end of one element.

The Element structure is: *[SICK ID Hex value] [Code length] [Character match(es)]*

[SICK ID Hex value]

- Length: 2 byte

You can find the SICK ID hex value in the Symbology ID Table in the appendix on page 105.

Locate the Hex value for the symbology and scan the 2 digit hex values from the Option Codes.

99 is the universal number, indicating all symbologies.

[Code length]

- Length: 4 byte

Specify what length of data output will be acceptable for this symbology. When you calculate the length, you must consider the whole data string which includes the programmed Preamble, Postamble, Scanned Data Length, Prefix/Suffix Symbol ID or AIM ID. Scan the four digit data length from the Option Code.

40 is entered as 0040; 9999 is a universal number, indicating all lengths.

[Character match]

- Length: 2-8 byte

You can refer to HEX/ASCII Reference Table to find the Hex value that represents the character(s) you want to match. Use the Option Codes to scan the alphanumeric combination that represents the ASCII characters. You can match up to 4 characters which are counted from the start character of the whole Data String.

Note: When setting the matched character(s), you must match the content of the whole Data String, including the programmed Preamble, Postamble, Scanned Data Length, Prefix/Suffix Symbol ID or AIM ID.

FF is the universal character, indicating all characters.

Batch Reading Rule Example

In this example, you are scanning Code 39, Code 128, and Code 93 bar codes, but you would like to output the data in following sequence: Code 128 - Code 39 - Code 93



You would set up the Batch Reading rule with the following command line:

[PROGRAM] [Batch Reading] [0301999941FF0799994243FF09999945464748FF] [FIN] [END]

The breakdown of the command line is shown below:

03	The number of elements in the overall rule
01	Code identifier of Code 128
9999	Code length that must match for Code 128, 9999 = all lengths
41	Start character match for Code 128, 41h = "A"
FF	End of first code
07	Code identifier of Code 39
9999	Code length that must match for Code 39, 9999 = all lengths
4243	Start character that must match for Code 39, 42h = "B", 43h = "C"
FF	End of second code
09	Code identifier of Code 93
9999	Code length that must match for Code 93, 9999 = all lengths

IDM corded & IDM Bluetooth

45464748 Start character match for Code 93, 45h = "E", 46h = "F", 47h = "G", 48h = "H"
 FF End of third code

To program the previous example using specific lengths, you would have to count the programmed Preamble, Postamble, Scanned Data Length, Prefix/Suffix Symbol ID or AIM ID if you had defined as part of the length. If you enable the Suffix Symbol ID of symbology, you would add one character to the previous example's length. You would set up the Batch Reading rule with the following command line:

```
[PROGRAM] [Batch Reading] [0301001141FF070011FF09001345464748FF] [FIN] [END]
```

The breakdown of the command line is shown below:

03 The number of elements in the overall rule
 01 Code identifier of Code 128
 0011 Code length that must match for Code 128
 A-CODE 128 sample length (10) plus Suffix Symbol ID (1) = 11
 41 Start character match for Code 128, 41h = "A"
 FF End of first code
 07 Code identifier of Code 39
 0011 Code length that must match for Code 39
 BC-CODE 39 sample length (10) plus Suffix Symbol ID (1) = 11
 FF Universal matched character indicating all characters. Also indicates end of second code.
 09 Code identifier of Code 93
 0013 Code length that must match for Code 93
 EFGH-CODE 93 sample length (12) plus Suffix Symbol ID (1) = 13
 45464748 Start character match for Code 93, 45h = "E", 46h = "F", 47h = "G", 48h = "H"
 FF End of third code



If the [Character match(es)] is set to "FF", the following "FF" which indicates the end of the code does not have to be set.

STX (RS-232/USB Com interface)	Preamble	Scanned Data Length	Prefix Symbol ID or Prefix AIM Symbol ID	Scanned Data modified by DataWizard	Suffix Symbol ID or Suffix AIM Symbol ID	Postamble	ETX (RS-232/USB Com interface)
1 character	1-15 characters	2-4 digits	1 or 3 characters	Variable length	1 or 3 characters	1-15 characters	1 character

3.12 Condensed Data Wizard

DataWizard is a data editing system provided specially for the IDM hand-held scanners. Through DataWizard, you can process the scanned data prior the transmission in many ways as: Insert, Delete, Match, Verify, Replace, Reorganize, and Repeat Transmission. It will help you to arrange the transmission of scanned data to any specific format without software modification. For further configuration options please use the IDM Set Up Tool¹. Through the IDM Set Up Tool, all settings and configurations can be done on-screen on Windows 2000 / XP / 7. A Condensed Version DataWizard is provided by each IDM series. Through this menu, the condensed DataWizard can be utilized via bar code menu readings with ease. All “Character” input should be referred to the ASCII/HEX Table listed in the Appendix (page 107) to find the matched HEX value.





3.12.1 Preamble, Postamble, Data Length, Symbol ID Transmission



PROGRAM



F_DEFAULT

Family Code Selection	P.C.	Parameter Selection	Option Code
Preamble 	SS	None ◆	FIN
	MS	1-15 characters	[00-7F], FIN
		Maximum 15-character input; scan “FIN” to terminate this selection.	
Postamble 	SS	None ◆	FIN
	MS	1-15 characters	[00-7F], FIN
		Maximum 15-character input; scan “FIN” to terminate this selection.	
Data Length Transmission 	SS	Disable ◆	0
	SS	Enable 2-4 digits data length transmission	1
Symbology ID Transmission 	SS	Disable symbology ID transmission ◆	0
	SS	Enable prefix symbology ID transmission	1
	SS	Enable suffix symbology ID transmission	2
	SS	Enable both prefix and suffix symbology ID transmission	3
	SS	Enable prefix AIM symbology ID transmission	4
	SS	Enable suffix AIM symbology ID transmission	5
	SS	Enable both prefix and suffix AIM symbology ID transmission	6

¹ The IDM Set Up Tool can be downloaded on www.mysick.com.

3.12.2 Data Formatter





The Data Formatter is used to edit the scanned raw data prior to transmitting the data to the host computers or terminals. It allows you to select desired barcode symbologies for formatter control and provides Multiple Position Insertion and Multiple Character Insertion (max three characters) in the identified position.



PROGRAM



F_DEFAULT

Family Code Selection	P.C.	Parameter Selection	1 st Option Code	2 nd Option Code
Formatter Control 	SS	Disable ◆	FIN	
	MS	Select one barcode symbology	(2 digits)	Automatic termination
	MS	Select all barcode symbologies	00	Automatic termination
1st insertion 	SS	Disable ◆	FIN	
	DS	Enable	Position: (2 digits)	[1-3 characters]; FIN
			Define position (refer to chapter 3.12.7)	max. 3 characters can be inserted
2nd insertion 	SS	Disable ◆	FIN	
	DS	Enable	Position: (2 digits)	[1-3 characters]; FIN
			Define position (refer to chapter 3.12.7)	max. 3 characters can be inserted
3rd insertion 	SS	Disable ◆	FIN	
	DS	Enable	Position: (2 digits)	[1-3 characters]; FIN
			Define position (refer to chapter 3.12.7)	max. 3 characters can be inserted
4th insertion 	SS	Disable ◆	FIN	
	DS	Enable	Position: (2 digits)	[1-3 characters]; FIN
			Define position (refer to chapter 3.12.7)	max. 3 characters can be inserted

While the Data Formatter is enabled, it arranges only scanned data without Preamble, Postamble, STX, ETX, Data Length, Prefix/Suffix Symbology ID or Record Suffix. All of the above programmable parameters perform the same function depending on your setting.

Regarding the “Bar Code Selection” and “Position Calculation” of data formatter, please refer to page 99 and 100 for details. All “Character” input should be referred to the ASCII/HEX Table listed in the Appendix (page 107) to find matched HEX value.

3.12.3 Data Verifier

The Data Verifier is used to provide advanced verification for error-free scanning and to work as an Embedded Data Transmitting Filter. All data must conform to the Identified Barcode Symbologies, Identified Data Length, and one to three Identified Characters in the checking position. Otherwise, the Hand-held scanner will not transmit the data to the host computers or terminals, but will instead issue 3 long beeps for verification error and skip the scanned data. The Data Verifier checks only scanned data without Preamble, Postamble, STX, ETX, Data Length, Prefix/Suffix Symbology ID or Record Suffix. Regarding the “Bar Code Selection” and “Position Calculation” of Data Verifier, please refer to page 99 and 100 for details. All “Character” input should be referred to the ASCII/HEX Table listed in the Appendix (page 107) to find matched HEX value.



PROGRAM



F_DEFAULT

Family Code Selection	P.C.	Parameter Selection	1 st Option Code	2 nd Option Code
Verifier Control 	SS	Disable ◆	FIN	
	MS	Select one barcode symbology	(2 digits)	Automatic termination
	MS	Select all barcode symbologies	00	Automatic termination
Identified Data Length 	SS	Disable ◆	FIN	
	DS	Enable	(2 digits)	
		Determine the identified data length for verification.		
1st identified character 	SS	Disable ◆	FIN	
	DS	Enable	Position: (2 digits)	[00-7F]
			Define position (refer to chapter 3.12.7)	1 character
2nd identified character 	SS	Disable ◆	FIN	
	DS	Enable	Position: (2 digits)	[00-7F]
			Define position (refer to chapter 3.12.7)	1 character
3rd identified character 	SS	Disable ◆	FIN	
	DS	Enable	Position: (2 digits)	[00-7F]
			Define position (refer to chapter 3.12.7)	1 character

3.12.4 Data Replacer

The Data Replacer is used to edit the scanned raw data prior to transmitting the data to the host computers or terminals. It allows you to select desired barcode symbologies for replacer control, and provides Multiple Position Replacement in the identified position.

All data must conform to the Identified Bar Code Symbologies, and one to three Identified Characters in the identified position. While the Data Replacer is enabled, it arranges only scanned data without Preamble, Postamble, STX, ETX, Data Length, Prefix/Suffix Symbology ID or Record Suffix.





Regarding the “Bar Code Selection” and “Position Calculation” of Data Replacer, please refer to page 99 and 100 for details. All “Character” input should be referred to the ASCII/HEX Table listed in the Appendix (page 107) to find matched HEX value.



PROGRAM



F_DEFAULT

Family Code Selection	P.C.	Parameter Selection	1 st Option Code	2 nd Option Code
Replacer Control 	SS	Disable ◆	FIN	
	MS	Select one barcode symbology	(2 digits)	Automatic termination
	MS	Select all barcode symbologies	00	Automatic termination
1st Replacement 	SS	Disable ◆	FIN	
	DS	Enable	Position: (2 digits)	[00-7F]
			Define position (refer to chapter 3.12.7)	1 character
2nd Replacement 	SS	Disable ◆	FIN	
	DS	Enable	Position: (2 digits)	[00-7F]
			Define position (refer to chapter 3.12.7)	1 character
3rd Replacement 	SS	Disable ◆	FIN	
	DS	Enable	Position: (2 digits)	[00-7F]
			Define position (refer to chapter 3.12.7)	1 character

3.12.5 Data Organizer





The Data Organizer is used to edit the scanned raw data prior to transmitting the data to the host computers or terminals. It allows you to select desired barcode symbologies for organizer control and provides maximum two identified positions to send the data forward or backward. It also allows you to control the transmitted data including or excluding the data of identification position. Please refer to the application example listed in page 100 for details. While the Data Organizer is enabled, it arranges only scanned data without Preamble, Postamble, STX, ETX, Data Length, Prefix/Suffix Symbology ID or Record Suffix. Regarding the “Bar Code Selection” and “Position Calculation” of Data Organizer, please refer to page 99 and 100 for details. All “Character” input should be referred to the ASCII/HEX Table listed in the Appendix (page 107) to find matched HEX value.



PROGRAM



F_DEFAULT

Family Code Selection	P.C.	Parameter Selection	1 st Option Code	2 nd Option Code
Organizer Control 	SS	Disable ◆	FIN	
	MS	Select one barcode symbology	(2 digits)	Automatic termination
	MS	Select all barcode symbologies	00	Automatic termination
1st Organization 	SS	Disable ◆	FIN	
	DS	Enable	Position: (2 digits)	0 (Forward) ◆ 1 (Backward)
			Define position (refer to chapter 3.12.7)	Define direction
2nd Organization 	SS	Disable ◆	FIN	
	DS	Enable	Position: (2 digits)	0 (Forward) ◆ 1 (Backward)
			Define position (refer to chapter 3.12.7)	Define direction
Include/ Exclude Control 	SS	Transmitted data excluded the data of identified position ◆	0	
	DS	Transmitted data included the data of identified position	1	

3.12.6 Select Barcode Symbology

You can select one or all types of barcode symbologies to use Condensed DataWizard for advanced transmission arrangement. If you scan “00” to select all types, the Hand-held scanner will arrange all incoming data to meet your pre-defined format. If you want to select only one type of barcode, please select one of the option codes listed below.

1D Barcode Symbology					
Code 128	01	EAN-8 with 5 supplement	45	UK/ Plessey	12
GS1-128	31	Codabar/ NW-7	06	Telepen	13
UPC-A	02	Code 39	07	GS1 DataBar	14
UPC-A with 2 supplement	32	Code 32	37	IATA	15
UPC-A with 5 supplement	42	Trioptic Code 39	47	Coupon Code	16
UPC-E	03	Matrix 2 of 5	38	PDF417/ Micro PDF417	17
UPC-E with 2 supplement	33	Interleaved 2 of 5	48	Codablock F	18
UPC-E with 5 supplement	43	China Postal Code	58	Code 16K	19
EAN-13	04	German Postal Code	68	Code 49	20
EAN-13 with 2 supplement	34	Standard/ Industrial 2 of 5	08	GS1 DataBar Limited	22
EAN-13 with 5 supplement	44	Code 93	09	GS1 DataBar Expanded	23
EAN-8	05	Code 11	10	Composite Codes	24
EAN-8 with 2 supplement	35	MSI/ Plessey	11	Micro PDF417	25

2D Barcode Symbology					
QR Code	A0	Maxi Code	A2	GS1 Data Matrix	A5
Micro QR Code	A0	Aztec Code	A3		
Data Matrix	A1	Chinese Sensible Code	A4		

Postal Codes					
Korea Post Code	21	Intelligent Mail barcode	B3	Planet Post	B6
Australian Post	B0	Japanese Post	B4	Postnet	B8
British Post	B1	KIX Post	B5		

3.12.7 Position Calculation

Data Formatter

If there is a 5-character input data string, refer to the following table to calculate the actual position for insertion:

	X		X		X		X		X	
00		01		02		03		04		05

Data Verifier, Data Replacer, Data Organizer

If there is an 11-character data string, please refer to the following table to calculate the actual position for identification.

X	X	X	X	X	X	X	X	X	X	X
00	01	02	03	04	05	06	07	08	09	10

3.12.8 Application Example

If your bar code label is a 16-digit Interleaved 2 of 5 which includes the information of 6-digit date code, 6-digit serial number and 4-digit unit price, you want the Hand-held scanner to do the following for you without software modification:

- Apply only Interleaved 2 of 5 to the condensed DataWizard.
- Check bar code is actually with 16-digit length.
- Allow bar code output whose date code is leading with “9”.
- Three outputs with “TAB” suffix.
- The date code output should skip “9” and replaced it by “A”.
- The serial number output should be led with “SN”.
- The unit price output should be skipped the first 2 digits.
- Test Bar Code : 9 8 1 0 2 5 1 2 3 4 5 6 9 8 7 6
- Actual Output : A81025[TAB]SN123456[TAB]76[TAB]

Programming Procedure

Data Verifier

- Scan “Program” to enter the programming mode.
- Scan “Verifier Control” and set the barcode symbology to “48” (Interleaved 2 of 5).
- Scan “Identified Data Length” and set the length to “16”.
- Scan “1st Identified Character” and set the identified position to “00”, then set the identified character to “39” (Hex Code of 9).

IDM corded & IDM Bluetooth

Data Formatter

- Scan “Formatter Control” and set the barcode symbology to “48”.
- Scan “1st Insertion” and set the identified position to “06”, then inserted characters to “09” (Hex Code of TAB), “53” (Hex Code of S), “4E” (Hex Code of N).
- Scan “2nd Insertion” and set the identified position to “12”, then inserted character to “09”. At the end, you must scan “FIN” (Finish) code to terminate this selection.
- Scan “3rd Insertion” and set the identified position to “16”, then inserted character to “09”. At the end, you must scan “FIN” (Finish) code to terminate this selection.

Data Replacer

- Scan “Replacer Control” and set the barcode symbology to “48”.
- Scan “1st Replacement” and set the identified position to “00”, then replaced character to “41” (Hex Code of A).

Data Organizer

- Scan “Organizer Control” and set the barcode symbology to “48”.
- Scan “1st Organization” and set the identified position to “16”, then set the data transmission to “0” (forward).
- Scan “2nd Organization” and set the identified position to “17”, then set the data transmission to “1” (backward).
- Scan “END” (Exit) to terminate the programming.

**Important notice**

The Condensed DataWizard will follow the preset working flow as below:

Verifier ►► Formatter ►► Replacer ►► Organizer

Therefore when you set the identified position in the Data organizer, you must consider the inserted data which you already set via Data Formatter.

4 IDM Set Up Tool

The IDM Set Up Tool is a Windows based configuration software for IDM scanners. The IDM Set Up Software is available free of charge on www.mysick.com.

4.1 Configuration via IDM Set Up Tool

The following steps describe how to configure an IDM Scanner via the IDM Set Up Tool.

4.1.1 IDM Corded Scanners

1. Connect the scanner to the PC via RS-232 or USB Com¹.
2. Start the IDM Set Up Tool Software.
3. Scan the IDM Set Up Tool (Host Link) Code:



IDM Set Up Tool (Host Link)

4. You can either:

- upload the current configuration from the scanner:  Upload or
- open a new configuration:  Configure →  New Configuration

5. Do your settings via the IDM Set Up Tool.
6. By clicking on the “Apply”-button the download section opens. Scan the IDM Set Up (Host Link) Code again and choose the correct Com Port.
7. Click on the download button to start the download. Your settings will be downloaded to the scanner. After a successful download you can close the IDM Set Up Tool.

4.1.2 IDM Bluetooth Scanners

1. Make sure, that the Scanner is paired with the base station (pair mode).
2. The interface has to be set to RS232 or USB COM. You can test the communication with any terminal program. After testing close the terminal program so that the com port is free again.
3. Scan the Uninstall Code. Then scan the IDM Set Up (Host Link) Code and place the scanner right the way into its base cradle.
4. Start the IDM Set Up Tool Software and click on “Upload”.
5. Choose the right Communication Port (COM Port). Afterwards click on the Upload button. The software will connect to the scanner and the Configuration Window opens.
6. Do your settings.
7. By clicking on the Apply button the download section opens. It’s important that you scan the IDM Set Up (Host Link) code again and place the scanner back inside the base cradle.
8. Click on the download button to start the download. After a successful download you can close the IDM Set Up Tool.
9. To re-connect scanner and base station, scan the “pair mode”- code and place the scanner in the base station.

¹ Make sure that the USB Com Port driver is installed

4.2 Firmware Upgrade via IDM Set Up Tool

The following chapters describe how to do a firmware upgrade via the IDM Set Up Tool.

4.2.1 IDM Corded Scanner

1. Connect the scanner to the PC via RS-232 or USB Com Port.
2. Open the IDM Set Up Tool.
3. Click on "Upgrade".
4. In the tree menu find the location of the scanner firmware.
5. Select the new firmware and click "OK".
6. Scan the IDM Set Up (Host Link) codes:



7. Choose the right Com Port.
8. Press "Upgrade".
9. The screen will dim and the firmware will begin uploading to the base station. You will hear some beeps while the process takes place. (Do not interrupt the upgrading process.)
10. After a successful firmware upgrade click on "Abort".

4.2.2 IDM Bluetooth Scanner

1. Connect the smart cradle with your PC.
2. Scan the "Uninstall" command:



3. Scan the IDM Set Up Tool (Host Link) code:



4. Place the scanner immediately into the smart cradle.
5. Open the IDM Set Up Tool.
6. Click on "Upgrade".
7. Choose the correct firmware and click on "OK".
8. Choose the right Communication Port (COM Port) and click on "Upgrade".
9. Wait until the firmware upgrade was completed successfully:

Completed !



4.2.3 IDM Bluetooth Cradle

1. Make sure that Scanner and the smart cradle are in “uninstall” state.
2. Connect the Cradle via an USB cable to your PC.
3. Make sure the USB 3.0 Bus Power Switch on the underside of the cradle is in the OFF position.
4. Remove the power cable from the cradle.
5. Press the Paging/Reset Button on the cradle and keep it pressed while you plug in the power cable.
6. Wait until the Status LED on the cradle starts blinking green before you release the Paging/Reset Button.



This step in the process automatically places the cradle in USB COM Emulation mode.

7. Do not place the scanner back into the cradle.
8. Open the IDM Set Up Tool.
9. Click on “Upgrade” → The open file box will open.
10. In the tree menu find the location of the cradle firmware.
11. Choose the Smart Cradle firmware and click “OK”.
12. Choose the correct Com Port and click on “Upgrade”.
13. The screen will dim and the firmware will begin uploading to the base station. You will hear some beeps while the process takes place. (Do not interrupt the upgrading process.)
14. After a successful firmware upgrade click on “Abort”.
15. Once you have finished upgrading the scanner, scan the “Pair Mode” code and place the scanner back into the cradle to reconnect the scanner to the base:



Pair Mode

5 Appendix

5.1 Symbology ID Table (1D Codes)

Each AIM Code Identifier contains the three-character string **]cm** where:

] = Flag Character; c = Code Character; m = Modifier Character

Code Family	Primary Format	SICK ID		AIM ID	
		Hex Value	Char.	Code Char.	Modified Char.
UPC	UPC-A	2	A	E	0
	UPC-A with 2 suppl.	32			1
	UPC-A with 5 suppl.	42			2
	UPC-E	3	E		0
	UPC-E with 2 suppl.	33			1
	UPC-E with 5 suppl.	43			2
Example: A UPC-A bar code 012345678950 with 2 supplement 12 is transmitted as]E0012345678950]E112					
Code 128	Code 128	01	B	C	m
	GS1-128	31	C		1
Codabar	Codabar/NW-7	06	D	F	m
Code 25	Standard/Industrial 2 of 5	08	I	S	0
	Matrix 2 of 5	38	K	X	0
	Interleaved 2 of 5	48	J	I	m
	China Postal Code	58	L	X	0
	German Postal Code	68	M	I	M
IATA	IATA	15	O	R	M
UCC Coupon	UCC Coupon Code	Z			
	Example: An UPC-A 512345678900 + GS1-128 81010123451297 barcode is transmitted as]E0512345678900]C181010123451297				
	Example: An EAN-13 9923456789019 + GS1-128 81010123451297 barcode is transmitted as]E09923456789019]C181010123451297				
EAN/ JAN	EAN/JAN-8	05	N	E	4
	EAN/JAN-8 with 2 suppl.	35			1
	EAN/JAN-8 with 5 suppl.	45			2
	EAN/JAN-13	04	F		0
	EAN/JAN-13 with 2 suppl.	34			1
	EAN/JAN-13 with 5 suppl.	44			2
Example: An EAN/JAN-8 barcode 49123562 with 5 supplements 12345 is transmitted as]E449123562]E212345					
Code 39	Code 39	09	H	G	m
Code 11	Code 11	10	P	H	m
MSI/ Plessey	MSI/ Plessey	11	R	M	m
UK/ Plessey	UK/ Plessey	12	S	P	0
Telepen	Telepen	13	T	B	m
GS1 Databar	GS1 DataBar	14	X	e	m
	GS1 DataBar Limited	22			
	GS1 DataBar Expanded	23			
Composite Code	Composite Code	24			
Code 39	Code 39	07	G	A	m
	Code 39 Trioptic	47	W	X	0
	Code 32	37	G	A	0
Code 49	Code 49	20	U	T	m
PDF417	PDF417/ Micro PDF417	17/ 25	V	L	m
Codablock	Codablock F	18	Y	O	m
Korea Post	Korea Post Code	21	a	X	0
Remark: Above examples are given for the transmission of AIM ID.					

5.2 Symbology ID table (2D and Post codes)

Code Family	Primary Format	SICK ID		AIM ID		
		Hex Value	Char.	Code Char.	Modified Char.	
QR Code	QR Code	A0	b	Q	m	
Micro QR Code	Micro QR Code					
Data Matrix	Data Matrix	A1	c	d	m	
	GS1 Data Matrix	A5				
Aztec Code	Aztec Code	A3	e	z	m	
Australian Post	Australian Post	B0	g	X	0	
British Post	British Post	B1	h	X	0	
Intelligent Mail Barcode	Intelligent Mail Barcode	B3	j		0	
Japanese Post	Japanese Post	B4	k		0	
KIX Post	KIX Post	B5	l		0	
Planet Code	Planet Code	B6	m		0	
Postnet	Postnet	B8	o			0
						0

5.3 Keyboard Function Code Table

No.	ANSI	ASCII	Key Function	Ctrl Output	No.	ANSI	ASCII	Key Function	Ctrl Output
00	NUL	00H	RESERVED	Ctrl + @	16	DLE	10H	F7	Ctrl + P
01	SOH	01H	CTRL (Left)	Ctrl + A	17	DC1	11H	F8	Ctrl + Q
02	STX	02H	ALT (Left)	Ctrl + B	18	DC2	12H	F9	Ctrl + R
03	ETX	03H	SHIFT	Ctrl + C	19	DC3	13H	F10	Ctrl + S
04	EOT	04H	CAPS LOCK	Ctrl + D	20	DC4	14H	F11	Ctrl + T
05	ENQ	05H	NUM LOCK	Ctrl + E	21	NAK	15H	F12	Ctrl + U
06	ACK	06H	ESC	Ctrl + F	22	SYN	16H	INS (Insert) (Edit)	Ctrl + V
07	BEL	07H	F1	Ctrl + G	23	ETB	17H	DEL (Delete) (Edit)	Ctrl + W
08	BS	08H	BACK SPACE	Ctrl + H	24	CAN	18H	HOME (Edit)	Ctrl + X
09	HT	09H	TAB	Ctrl + I	25	EM	19H	END (Edit)	Ctrl + Y
10	LF	0AH	F2	Ctrl + J	26	SUB	1AH	PAGE UP (Edit)	Ctrl + Z
11	VT	0BH	F3	Ctrl + K	27	ESC	1BH	PAGE DOWN (Edit)	Ctrl + [
12	FF	0CH	F4	Ctrl + L	28	FS	1CH	UP (Edit)	Ctrl + \
13	CR	0DH	ENTER (CR)	Ctrl + M	29	GS	1DH	DOWN (Edit)	Ctrl +]
14	SO	0EH	F5	Ctrl + N	30	RS	1EH	LEFT (Edit)	Ctrl + 6
15	SI	0FH	F6	Ctrl + O	31	US	1FH	RIGHT (Edit)	see note ¹⁾

¹⁾ To emulate the keyboard function key input for user definable parameters, the user must configure actual content using the Reserved ASCII 00 – 31 characters and also enable the “Function Key Emulation”. Otherwise, the Ctrl output will be done by the scanner. Please refer to the above Keyboard Function Code Table which is for IBM PC/XT/AT, PS/2, PS/VP, COMPAQ PC, HP Vectra PC, Notebook PC, APPLE and PowerMac, and WYSE PC Enhanced or fully compatible machines. The last character in the Ctrl output column varies for different countries.

Country (refer to Keyboard Layout) & Character						
United States	-	Spain	-	Denmark	-	Germany
Belgium	-	Switzerland	-	Italy	-	Norway
Sweden	-	UK	-	France	=	

5.4 ASCII Input Shortcut (Reference Table)

To configure the user definable parameters of the Hand-held scanner via the programming menu, the scanner will ask you to scan your desired ASCII value in HEX form. You have to refer to the “HEX/ASCII Table” for details.

H \ L	0	1	2	3	4	5	6	7
0	NUL	DLE	SPACE	0	@	P	~	p
1	SOH	DC1	!	1	A	Q	a	q
2	STX	DC2	"	2	B	R	b	r
3	ETX	DC3	#	3	C	S	c	s
4	EOT	DC4	\$	4	D	T	d	t
5	ENQ	NAK	%	5	E	U	e	u
6	ACK	SYN	&	6	F	V	f	v
7	BEL	ETB	'	7	G	W	g	w
8	BS	CAN	(8	H	X	h	x
9	HT	EM)	9	I	Y	i	y
A	LF	SUB	*	:	J	Z	j	z
B	VT	ESC	+	;	K	[k	{
C	FF	FS	,	<	L	\	l	
D	CR	GS	-	=	M]	m	}
E	SO	RS	.	>	N	^	n	~
F	SI	US	/	?	O	_	o	DEL

 Example: ASCII “A” → HEX “41”; ASCII “a” → HEX “61”

 : High Byte of HEX Value















































 : Low Byte of HEX Value

Example:



























































If you want the scanned data output leading with a Dollar Sign, you have to set the “Preamble” to “\$”. The configuration procedure is listed below for reference.















































- Scan the system command – PROGRAM listed on page 33 and 36 to enter programming mode.
- Scan family code – PREAMBLE to select this family.
- Refer to the Hex/ASCII Table, you will find the HEX value of “\$” is 24.
- Scan the option code – 2 listed on page 116.
- Scan the option code – 4 listed on page 116.
- Scan the system command – FIN (Finish) to terminate Preamble setting.
- Scan the system command – End to exit the programming mode for normal operation.

5.5 GS1-128 ASCII Table

ASCII Index	RS232 I/F USB(COM) I/F	USB(HID) I/F AT wedge I/F	CMD Barcode	ASCII Index	RS232 I/F USB(COM) I/F	USB(HID) I/F AT wedge I/F	CMD Barcode
00	- None for AI prefix/suffix - NUL for others	N/A		14	DC4	Ctrl + T	
01	SOH	Ctrl + A		15	NAK	Ctrl + U	
02	STX	Ctrl + B		16	SYN	Ctrl + V	
03	ETX	Ctrl + C		17	ETB	Ctrl + W	
04	EOT	Ctrl + D		18	CAN	Ctrl + X	
05	ENQ	Ctrl + E		19	EM	Ctrl + Y	
06	ACK	Ctrl + F		1A	SUB	Ctrl + Z	
07	BEL	Ctrl + G		1B	ESC	N/A	
08	BS	Ctrl + H		1C	FS	N/A	
09	HT	Ctrl + I		1D	GS	N/A	
0A	LF	Ctrl + J		1E	RS	N/A	
0B	VT	Ctrl + K		1F	US	N/A	
0C	FF	Ctrl + L		20	SP	SP	
0D	CR	Ctrl + M		21	!	!	
0E	SO	Ctrl + N		22	"	"	
0F	SI	Ctrl + O		23	#	#	
10	DLE	Ctrl + P		24	\$	\$	
11	DC1	Ctrl + Q		25	%	%	
12	DC2	Ctrl + R		26	&	&	
13	DC3	Ctrl + S		27	'	'	
28	((	3F	?	?	
29))		40	@	@	
2A	*	*		41	A	A	
2B	+	+		42	B	B	
2C	,	,		43	C	C	
2D	-	-		44	D	D	





















































IDM corded & IDM Bluetooth

2E	.	.		45	E	E	
2F	/	/		46	F	F	
30	0	0		47	G	G	
31	1	1		48	H	H	
32	2	2		49	I	I	
33	3	3		4A	J	J	
34	4	4		4B	K	K	
35	5	5		4C	L	L	
36	6	6		4D	M	M	
37	7	7		4E	N	N	
38	8	8		4F	O	O	
39	9	9		50	P	P	
3A	:	:		51	Q	Q	
3B	;	;		52	R	R	
3C	<	<		53	S	S	
3D	=	=		54	T	T	
3E	>	>		55	U	U	
56	V	V		6D	m	m	
57	W	W		6E	n	n	
58	X	X		6F	o	o	
59	Y	Y		70	p	p	
5A	Z	Z		71	q	q	
5B	[[	72	r	r	
5C	\	\		73	s	s	
5D]]		74	t	t	
5E	^	^		75	u	u	
5F	_	_		76	v	v	
60	`	`		77	w	w	
61	a	a		78	x	x	

62	b	b		79	y	y	
63	c	c		7A	z	z	
64	d	d		7B	{	{	
65	e	e		7C			
66	f	f		7D	}	}	
67	g	g		7E	~	~	
68	h	h		7F	DEL	Ctrl + Backspace	
69	i	i		80	N/A	F1	
6A	j	j		81	N/A	F2	
6B	k	k		82	N/A	F3	
6C	l	l		83	N/A	F4	
84	N/A	F5		91	N/A	←(Left Arrow)	
85	N/A	F6		92	N/A	PageUp	
86	N/A	F7		93	N/A	PageDown	
87	N/A	F8		94	N/A	Enter	
88	N/A	F9		95	N/A	Delete	
89	N/A	F10		96	N/A	Insert	
8A	N/A	F11		97	N/A	Home	
8B	N/A	F12		98	N/A	End	
8C	N/A	Tab		99	N/A	BackSpace	
8D	N/A	Esc		9A	N/A	Shift +	
8E	N/A	↓(Down Arrow)		9B	N/A	Ctrl +	
8F	N/A	↑(Up Arrow)		9C	N/A	Alt +	
90	N/A	→(Right Arrow)					





“Shift +”, “Ctrl +” and “Alt +”: Read the direct input menu barcode twice when you output only Shift, Ctrl and Alt.

5.6 Application Identifier Table

Application Identifier	FNC1 at Data Terminal	FNC1 Required	CMD Barcode	Application Identifier	FNC1 at Data Terminal	FNC1 Required	CMD Barcode
00	Unnecessary			251	Indispensability	(FNC1)	
01	Unnecessary			252	Unnecessary		
02	Unnecessary			30	Indispensability	(FNC1)	
10	Indispensability	(FNC1)		310D	Unnecessary		
11	Unnecessary			311D	Unnecessary		
12	Unnecessary			312D	Unnecessary		
13	Unnecessary			313D	Unnecessary		
15	Unnecessary			314D	Unnecessary		
17	Unnecessary			315D	Unnecessary		
20	Unnecessary			316D	Unnecessary		
21	Indispensability	(FNC1)		320D	Unnecessary		
22	Indispensability	(FNC1)		321D	Unnecessary		
23L	Indispensability			322D	Unnecessary		
Data field length=2L+1 Example 231, it is 2×1+1=3							
240	Indispensability	(FNC1)		323D	Unnecessary		
241	Indispensability	(FNC1)		324D	Unnecessary		
250	Indispensability	(FNC1)		325D	Unnecessary		
326D	Unnecessary			347D	Unnecessary		
327D	Unnecessary			348D	Unnecessary		
328D	Unnecessary			349D	Unnecessary		
329D	Unnecessary			350D	Unnecessary		
330D	Unnecessary			351D	Unnecessary		
331D	Unnecessary			352D	Unnecessary		
332D	Unnecessary			353D	Unnecessary		
333D	Unnecessary			354D	Unnecessary		
334D	Unnecessary			355D	Unnecessary		
335D	Unnecessary			356D	Unnecessary		

336D	Unnecessary			357D	Unnecessary		
337D	Unnecessary			360D	Unnecessary		
340D	Unnecessary			361D	Unnecessary		
341D	Unnecessary			362D	Unnecessary		
342D	Unnecessary			363D	Unnecessary		
343D	Unnecessary			364D	Unnecessary		
344D	Unnecessary			365D	Unnecessary		
345D	Unnecessary			366D	Unnecessary		
346D	Unnecessary			367D	Unnecessary		
368D	Unnecessary			422	Indispensability	(FNC1)	
369D	Unnecessary			423	Indispensability	(FNC1)	
37	Indispensability	(FNC1)		7002	Indispensability	(FNC1)	
390D	Indispensability	(FNC1)		7030	Indispensability		
391D	Indispensability	(FNC1)		7031	Indispensability		
392D	Indispensability	(FNC1)		7032	Indispensability		
393D	Indispensability	(FNC1)		7033	Indispensability		
400	Indispensability	(FNC1)		7034	Indispensability		
401	Indispensability	(FNC1)		7035	Indispensability		
402	Indispensability	(FNC1)		7036	Indispensability		
403	Indispensability	(FNC1)		7037	Indispensability		
410	Unnecessary			7038	Indispensability		
411	Unnecessary			7039	Indispensability		
412	Unnecessary			8001	Indispensability	(FNC1)	
413	Unnecessary			8002	Indispensability	(FNC1)	
414	Unnecessary			8003	Indispensability	(FNC1)	
415	Unnecessary			8004	Indispensability	(FNC1)	
420	Indispensability	(FNC1)		8005	Indispensability	(FNC1)	
421	Indispensability	(FNC1)		8006	Indispensability	(FNC1)	
8007	Indispensability	(FNC1)		92	Indispensability	(FNC1)	

IDM corded & IDM Bluetooth

8008	Indispensability	(FNC1)		93	Indispensability	(FNC1)	
8018	Indispensability	(FNC1)		94	Indispensability	(FNC1)	
8020	Indispensability	(FNC1)		95	Indispensability	(FNC1)	
8100	Indispensability	(FNC1)		96	Indispensability	(FNC1)	
8101	Indispensability	(FNC1)		97	Indispensability	(FNC1)	
8102	Indispensability	(FNC1)		98	Indispensability	(FNC1)	
90	Indispensability	(FNC1)		99	Indispensability	(FNC1)	
91	Indispensability	(FNC1)					

5.7 Host Interface Quick Set



USB HID Standard Mode ◆



PS/2 (DOS/V) KBW Standard Mode



RS-232 Serial



USB Com Port Emulation
(additional driver needed,
available on www.sick.com)



PS/2 (DOS/V) KBW Turbo Mode



USB HID Turbo Mode



PS/2 (DOS/V) Keyboard
Replacement



For IDM Bluetooth scanners the above host interface quick commands are only available when working with a smart cradle.

5.8 Operation Mode Quick Set

5.8.1 1D Corded Scanners (IDM1x0 series)



Low Power (Low Power Trigger)



Force (Continued power on)



Alternative (Periodic Power off)



Trigger (External Triggering) ◆

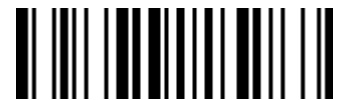

Toggle (Repeat reading)



Flash (Pulse driven reading)



Presentation (Auto Sensing)



Diagnostic (Test reading)



Level (Auto power off)

5.8.2 2D Corded Scanners (IDM2x0 series)



5.8.3 Bluetooth Scanners



5.9 Link Mode Quick Set

The Link Mode commands are only relevant for IDM Bluetooth scanners.



PAIR Mode



PICO Mode



Uninstall



SSP Master



SSP Slave



HID Mode



HID Legacy Mode



HID Mode with Passkey

5.10 System Commands



PROGRAM
(Enter Programming Mode)



System Information List (SYSLIST)



Safe User Default



FIN (Finish)



IDM Set Up Tool (Host Link)



User Default



END
(Exit Programming Mode)



Master Default



Factory Default

Factory Default: After scanning “Factory Default” command, all parameters will be returned to factory default value. In addition, for IDM Bluetooth scanners the radio link will be disconnected and the scanner will revert to uninstall state.

Master Default: After scanning “Master Default” command, the scanner will remain the pre-set parameters of Host Interface Selection, Keyboard Interface Control (except Record Suffix; Preamble; Postamble), Serial Interface Control (except Record Suffix; Preamble; Postamble) and Wand/Laser Emulation Control. The rest of the parameters will be returned to default value. (For IDM Bluetooth scanners the Bluetooth device name, Bluetooth PIN Code and Out-of-Range Scanning parameters will also be remained. The radio link will be kept on.)

User Default: After scanning “Save User Default” command, all current parameters will be stored to the flash memory. Once you change the parameter and would like to return to previous setting, please scan “User Default”.

Additional System Commands for IDM Bluetooth Scanners



Sleep



Save Configuration



Power Off



Paging



Clone

5.11 Option Codes



0



A



5



1



B



6



2



C



7



3



D



8



4



E



9



F



Abort



FIN (Finish)



END (Exit)

Australia

Phone +61 3 9457 0600
1800 33 48 02 – tollfree
E-Mail sales@sick.com.au

Belgium/Luxembourg

Phone +32 (0)2 466 55 66
E-Mail info@sick.be

Brasil

Phone +55 11 3215-4900
E-Mail marketing@sick.com.br

Canada

Phone +1 905 771 14 44
E-Mail information@sick.com

Česká republika

Phone +420 2 57 91 18 50
E-Mail sick@sick.cz

China

Phone +86 4000 121 000
E-Mail info.china@sick.net.cn
Phone +852-2153 6300
E-Mail ghk@sick.com.hk

Danmark

Phone +45 45 82 64 00
E-Mail sick@sick.dk

Deutschland

Phone +49 211 5301-301
E-Mail info@sick.de

España

Phone +34 93 480 31 00
E-Mail info@sick.es

France

Phone +33 1 64 62 35 00
E-Mail info@sick.fr

Great Britain

Phone +44 (0)1727 831121
E-Mail info@sick.co.uk

India

Phone +91-22-4033 8333
E-Mail info@sick-india.com

Israel

Phone +972-4-6881000
E-Mail info@sick-sensors.com

Italia

Phone +39 02 27 43 41
E-Mail info@sick.it

Japan

Phone +81 (0)3 5309 2112
E-Mail support@sick.jp

Magyarország

Phone +36 1 371 2680
E-Mail office@sick.hu

Nederland

Phone +31 (0)30 229 25 44
E-Mail info@sick.nl

Norge

Phone +47 67 81 50 00
E-Mail sick@sick.no

Österreich

Phone +43 (0)22 36 62 28 8-0
E-Mail office@sick.at

Polska

Phone +48 22 837 40 50
E-Mail info@sick.pl

România

Phone +40 356 171 120
E-Mail office@sick.ro

Russia

Phone +7-495-775-05-30
E-Mail info@sick.ru

Schweiz

Phone +41 41 619 29 39
E-Mail contact@sick.ch

Singapore

Phone +65 6744 3732
E-Mail sales.gsg@sick.com

Slovenija

Phone +386 (0)1-47 69 990
E-Mail office@sick.si

South Africa

Phone +27 11 472 3733
E-Mail info@sickautomation.co.za

South Korea

Phone +82 2 786 6321/4
E-Mail info@sickkorea.net

Suomi

Phone +358-9-25 15 800
E-Mail sick@sick.fi

Sverige

Phone +46 10 110 10 00
E-Mail info@sick.se

Taiwan

Phone +886 2 2375-6288
E-Mail sales@sick.com.tw

Türkiye

Phone +90 (216) 528 50 00
E-Mail info@sick.com.tr

United Arab Emirates

Phone +971 (0) 4 88 65 878
E-Mail info@sick.ae

USA/México

Phone +1(952) 941-6780
1 (800) 325-7425 – tollfree
E-Mail info@sickusa.com

More representatives and agencies
at www.sick.com